

# SYSTEM 3400

(with 34000 Devices)

## ***A***NALOGUE ***A***DDRESSABLE ***F***IRE ***D***ETECTION ***A***ND ***A***LARM ***S***YSTEM

Operating Manual  
Version 3.3X  
13499-26 Issue 2  
September 1996

Caradon Gent Limited  
Waterside Road  
Hamilton Industrial Park  
Leicester, LE5 1TN  
Tel: 0116 2462000  
Telex: 342367 Fax: 0116 2462300

User responsibility

Control and indicating  
equipment

Quick reference

Emergency  
conditions

Other controls

Site labels

Log book sheets

Index

Parts list

**GENT and customer  
services**

## Preface

This **second issue** of the Operating manual for System 3400 (with 34000 devices) contains updates to include the 34604 A4 Mimic panel.

The first issue covered instructions for operating the equipment in a standalone and network systems (**System 3400 & 3500**). The products covered are 3404/8 Control Panels, 3450 Repeat panel, 3460 Mimic and Zonal panels and the 3505 Terminal node.

There are step by step instructions on what to do in an emergency and when operating other controls.

## Associated Documents

13563-011 GENT Supervisor Operating Manual

13499-23 Installation Manual for System 3400 (with 34000 devices)

## Conventions

**NOTE** : A note highlight important text that is normally hidden in the main text.

**CAUTION** : A caution is given to prevent damage to equipment.

**WARNING** : A warning is given to advise of dangerous conditions that may result in injury or death.

Issue Record			
Section	Issue	Date	Comments
Prelims	2	9/96	This is the second issue of Operating Manual System 3400 (with 34000 devices)
1 - 7	2	9/96	
Index	2	9/96	
Parts	4	9/96	
Phone			

The information contained herein is the property of CARADON GENT LIMITED and is supplied without liability for errors or omissions. No part of the manual may be reproduced in any form soever without prior consent of the company. Due to the on going development of GENT System 3400 (with 34000 devices) the information contained in the manual is subject to change without notice.

## *Customer feedback*

*If you have any comments on this manual,  
then please provide them below.*

*Post completed sheet to the address overleaf or  
pass on to your area sales representative.*

*Thanks*

Your name: \_\_\_\_\_

Address: \_\_\_\_\_

\_\_\_\_\_

\_\_\_\_\_

Manual number and title \_\_\_\_\_

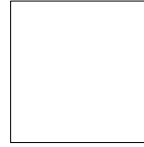

Technical Publications  
Caradon Gent Limited  
Waterside Road  
Leicester  
LE5 1TN

---

---

# Table of contents

<b>User Responsibility</b> . . . . .	<b>1-1</b>
<b>Daily</b> . . . . .	<b>1-1</b>
<b>Weekly</b> . . . . .	<b>1-1</b>
<b>Quarterly</b> . . . . .	<b>1-2</b>
<b>Battery Replacement</b> . . . . .	<b>1-2</b>
Panel Battery . . . . .	1-2
Memory Card Battery . . . . .	<b>1-2</b>
<b>Manual Call Point</b> . . . . .	<b>1-2</b>
Testing a Manual Call Point . . . . .	1-2
Replacing a broken Glass . . . . .	1-3
<b>Installing the Printer Paper</b> . . . . .	<b>1-4</b>
Printer Operation . . . . .	1-4
<b>Control and indicating equipment</b> . . . . .	<b>2-1</b>
<b>Visual and audible Indications</b> . . . . .	<b>2-1</b>
<b>Normal Condition</b> . . . . .	<b>2-2</b>
<b>Quick Reference</b> . . . . .	<b>3-1</b>
<b>How to raise an ALARM of Fire</b> . . . . .	<b>3-2</b>
<b>In the event of a FIRE condition</b> . . . . .	<b>3-2</b>
<b>In the event of a FAULT condition</b> . . . . .	<b>3-2</b>
<b>In the event of a WARNING Condition</b> . . . . .	<b>3-3</b>
<b>How to sound all FIRE ALARMS</b> . . . . .	<b>3-3</b>
To Sound Alarms . . . . .	3-3
To Silence Alarms . . . . .	3-3
<b>How to Test the Display and Indicators</b> . . . . .	<b>3-3</b>
<b>How to sound the Master Alarms</b> . . . . .	<b>3-4</b>
<b>How to sound Sector Alarms</b> . . . . .	<b>3-4</b>
<b>Emergency Conditions</b> . . . . .	<b>4-1</b>
<b>How to raise an ALARM of Fire</b> . . . . .	<b>4-1</b>
<b>In the event of a FIRE Condition</b> . . . . .	<b>4-2</b>
To Silence Alarms . . . . .	4-2
To Reset the System . . . . .	4-2

Fire Indications . . . . .	4-3
<b>In the event of a FAULT condition . . . . .</b>	<b>4-4</b>
To Cancel the Fault Buzzer . . . . .	4-4
Fault Indications . . . . .	4-4
Action to Rectify a Fault Event . . . . .	4-5
<b>In the event of a WARNING condition . . . . .</b>	<b>4-7</b>
Warning Indications . . . . .	4-7
Action to Remove a Warning Event . . . . .	4-7
<b>To sound all Fire Alarms globally . . . . .</b>	<b>4-9</b>
To Sound Alarms . . . . .	4-9
To Silence Alarms . . . . .	4-9
<b>To sound the Master Alarms . . . . .</b>	<b>4-10</b>
<b>To sound the Sector Alarms . . . . .</b>	<b>4-10</b>
<b>Operating the Other controls . . . . .</b>	<b>5-1</b>
<b>Testing the display and indicators . . . . .</b>	<b>5-2</b>
Testing the Mimic and Zonal panels . . . . .	5-2
<b>Setting the System Clock . . . . .</b>	<b>5-4</b>
<b>Viewing the current Fire Log . . . . .</b>	<b>5-6</b>
<b>Viewing the current Fault Log . . . . .</b>	<b>5-7</b>
<b>Viewing the current Warning log . . . . .</b>	<b>5-8</b>
<b>Viewing the Historic Log . . . . .</b>	<b>5-9</b>
<b>Viewing Supervisory Active Events . . . . .</b>	<b>5-10</b>
<b>Viewing the Supervisory log . . . . .</b>	<b>5-12</b>
<b>Changing the UserCode Password . . . . .</b>	<b>5-14</b>
<b>Using the Printer . . . . .</b>	<b>5-15</b>
<b>Editing Label Information . . . . .</b>	<b>5-17</b>
<b>Viewing Labels . . . . .</b>	<b>5-19</b>
<b>Saving changes to the Memory Card . . . . .</b>	<b>5-21</b>
<b>Enabling or Disabling Parts of the System . . . . .</b>	<b>5-22</b>
<b>Switching the Auxiliary Relays . . . . .</b>	<b>5-26</b>
<b>Viewing Cards Information . . . . .</b>	<b>5-27</b>
<b>Viewing a Loop Map . . . . .</b>	<b>5-28</b>
<b>Viewing Network Map . . . . .</b>	<b>5-29</b>
<b>Site Labels Information . . . . .</b>	<b>6-1</b>

---

Site Labels . . . . .	6-1
<b>Log Book Sheets . . . . .</b>	<b>7-1</b>
Logging Events . . . . .	7-1
Blank Log Sheets . . . . .	7-1
Completed Log Sheet . . . . .	7-1
<b>System 3400 (with 34000 devices)</b>	
<b>Parts list . . . . .</b>	<b>P-1</b>
Introduction . . . . .	P-1
Control and indicating equipment . . . . .	P-1
Cards . . . . .	P-2
Sensors and Accessories . . . . .	P-3
Alarm sounders . . . . .	P-4
Manual call points (MCP) 2-way . . . . .	P-4
Interfaces . . . . .	P-5
Manuals & Accessories . . . . .	P-6
GENT Supervisor . . . . .	P-6
Converter / Compactor / UPS / Printer . . . . .	P-7

# Table of figures

Figure 1-1 Replacing a broken MCP glass . . . . .	1-3
Figure 3-2 Loading the printer paper . . . . .	1-4
Figure 2-1 control and indicating panels . . . . .	2-1
Figure 2-2 Normal indications . . . . .	2-2
Figure 3-1 Control panel facia . . . . .	3-1
Figure 4-1 Fire indications and controls . . . . .	4-2
Figure 4-2 Fault indications and controls . . . . .	4-4
Figure 4-3 Warning Indications . . . . .	4-7
Figure 4-1 Sound alarms . . . . .	4-9
Figure 4-2 Silence Alarms . . . . .	4-9
Figure 5-1 Top level menu . . . . .	5-1
Figure 5-2 Lamp test on standard mimic panel . . . . .	5-2
Figure 5-3 Lamp test at A4 Mimic panel . . . . .	5-3
Figure 5-4 Set clock display . . . . .	5-4
Figure 5-5 Supervisory active . . . . .	5-10



# User Responsibility

It is recommended that the **persons responsible** for the fire alarm system should become familiar with the procedures on how to operate the controls and interpret indications given at specific products. Adequate **training** should also have been given from appointed personnel.

## British Standard

If your system is designed with a **3404 Control panel** that meets the requirements of *BS 5839:Part 4:1988*, then the use of **[Disable] [IO Line]** option under the **[Control ]** menu and **[Set Clock]** option under the **[Setup]** menu using the 'Customer Password' is not recommended.

## Daily

The British Standard code of practice for *Fire detection and alarm systems for buildings, BS 5839:Part 1:1988*, states that the system should be inspected daily to ensure that a normal indication is given at the control and indicating equipment and that any previously indicated **fault** and **warning** condition has received appropriate attention.

- a) It recommends entry into the Log Book provided of all the system events for future reference. **To view past events look at the Historic Events Log.**
- b) The person inspecting the protected premise can ensure that the use of the area(s) inspected has not changed such that the detection and alarm devices have become inappropriate.
- c) The area(s) can be inspected to check that no unsafe practices that could lead to fire are being undertaken.

## Weekly

At Weekly intervals a different **Fire Sensor** or **Manual Call Point** of the system should be tested to ensure the system is capable of operating under alarm condition.

- a) The operation of the **alarm sounders** should be checked, which also provides a regular reminder to those occupying the premises that there is a fire alarm system with a particular characteristic sound.
- b) The test should be performed at a regular time to avoid confusion between a test and a genuine fire alarm.

## Quarterly

At quarterly intervals the system should be inspected and any work necessary should be performed by trained maintenance engineer. The location of your nearest Caradon Gent Limited branch offices are included in this manual who would be able to help you on System 3400 Maintenance and Service.

## Battery Replacement

**NOTE:** Any servicing work on the System 3400 must be carried out by Caradon GENT Limited.

### Panel Battery

Under normal operating conditions the maintenance free **lead acid** batteries in the Control panel, Repeat panels, Mimic and Zonal panels, A4 Mimic control unit, Mains powered interface units and Terminal node can have a useful life of up to **5 years** from the date of manufacture.

**NOTE:** It is recommended that these batteries are replaced at 4 Yearly interval from the date the 3400 System is first commissioned.

### Memory Card Battery

Under normal operating conditions the **lithium** battery on the Memory Card in the Control Panel can have a useful life of up to 10 Years from the date of manufacture.

**NOTE:** It is recommended that the Memory Card is replaced at 10 Yearly interval from the date the System 3400 is commissioned.

## Manual Call Point

### Testing a Manual Call Point

Push the test key through the hole in the underside of the call point to engage the test cam mechanism and push to operate the cam mechanism.

At this point the test key is retained in the call point and pulling it out will reset the glass.

**NOTE:** The appropriate sounders in the system will be activated by this test. To **silence alarms** and **reset** the system, see **Emergency controls** part of this manual.

## Replacing a broken Glass

**WARNING:** Take appropriate precautions when clearing broken glass to prevent injury.

**NOTE:** A weather resistant version of manual call points will have two gaskets, a Cover/glass gasket and a Spacer/cover gasket, which must be installed in their respective position.

These procedures assume the cover on the manual call point is open and any broken glass has been cleared.

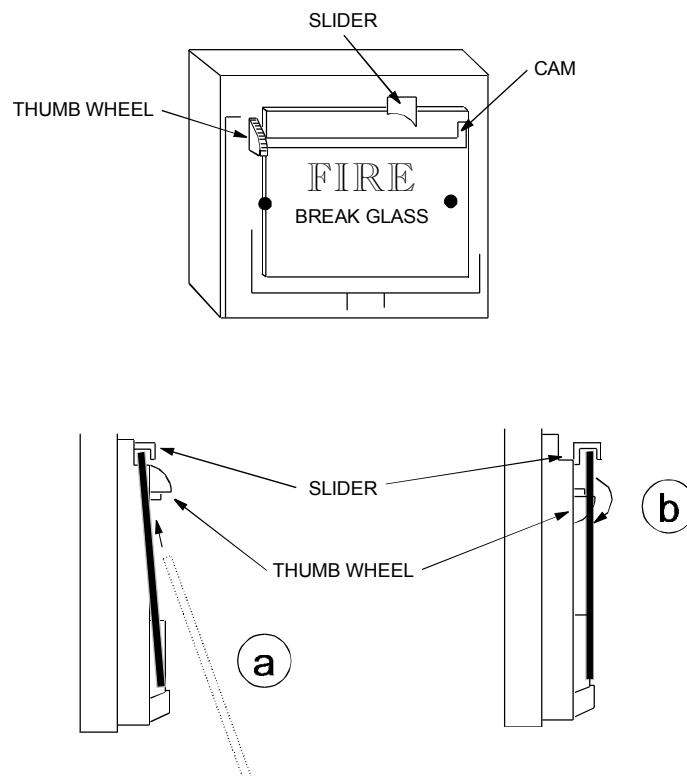

Figure 1-1 Replacing a broken MCP glass  
emf1216

- a) Feed the glass upward to push the cams down and fit under slider, locate bottom of glass into recess.
- b) Hold the bottom of glass in position and rotate the thumbwheel quadrant to raise the top of the glass.
- c) Fit the call point cover by hooking it into the top of the unit and making sure that the glass is properly seated (held down) tighten the cover fixing screw.

## Installing the Printer Paper

The printer paper roll is located on the inside of the inner door. A vertical line on the paper indicates end of paper. A new paper roll code number 13490-01 must be fitted.

- a) Open the control main and inner door using the key supplied.
- b) Remove the old paper roll from inside of door assembly.
- c) Fit a new paper roll
- d) Insert paper into the printer mechanism.

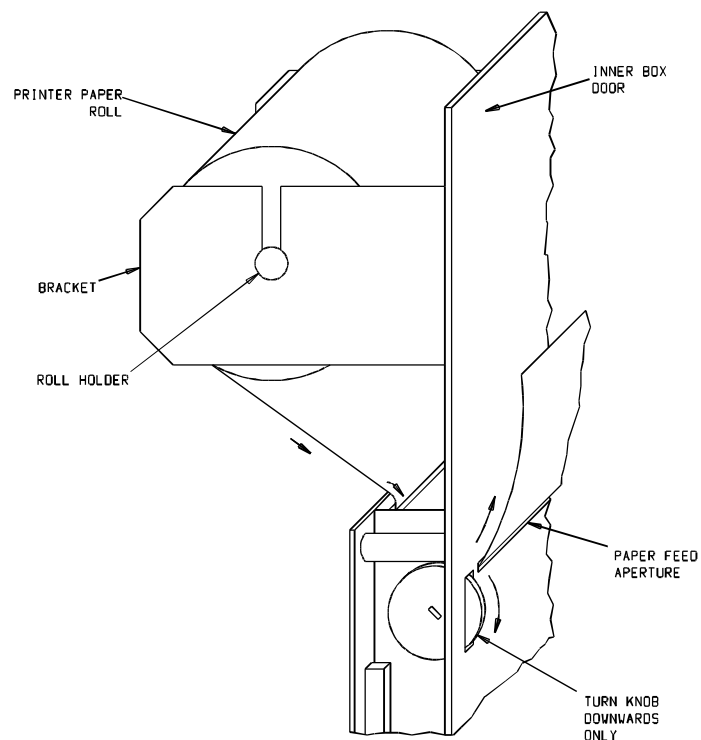

Figure 3-2 Loading the printer paper

f1171

- e) Turn the knob on the inner door *downwards* to feed the printer paper.
- g) Close the control panel door(s).
- f) Carry out a printer *paper test*, see section on **using the printer** in the **others controls** part of this manual.

## Printer Operation

The printer will operate if it is switched On and a printout is obtained upon occurrence of a system event.

# Control and indicating equipment

This control and indicating equipment covered in this manual include:

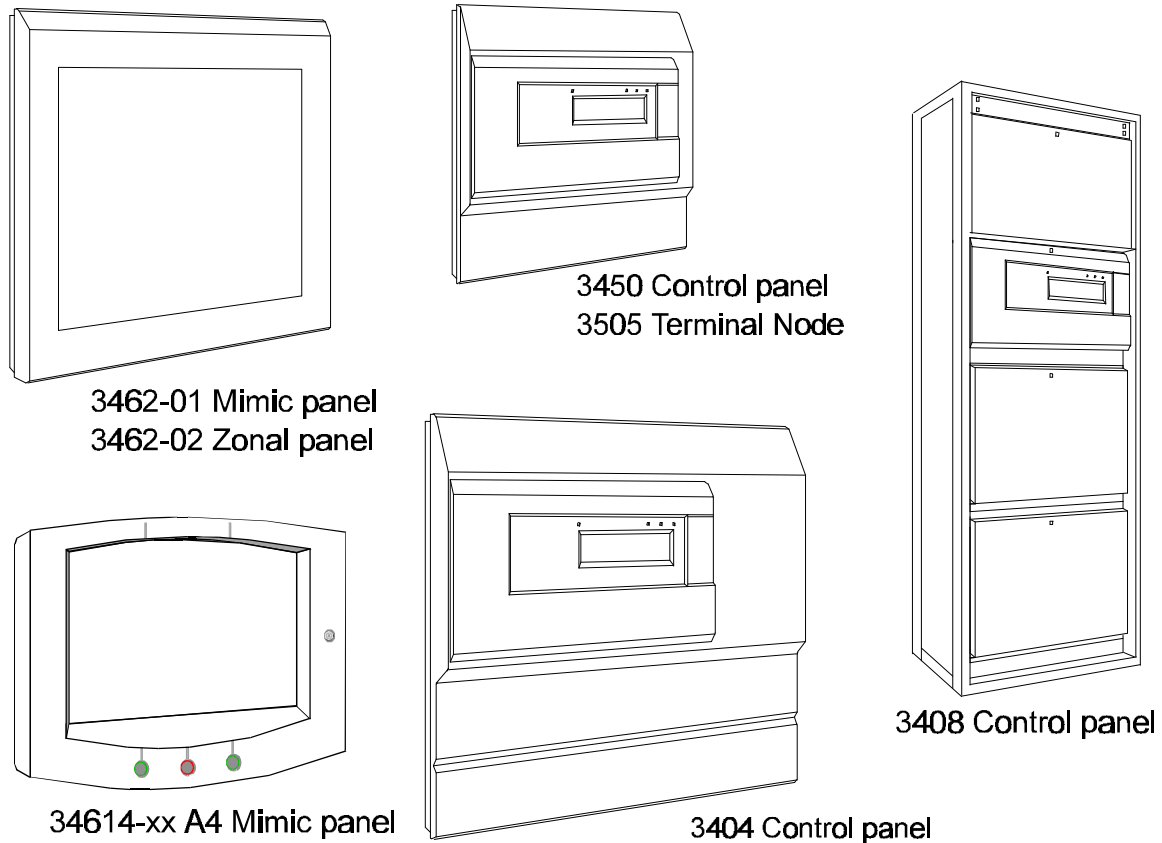

Figure 2-1 control and indicating panels  
f1381

The **3404/8 Control Panel** is at the heart of a standalone fire detection and alarm system. It registers all event occurrences monitored by each device (system equipment) installed in a protected premise and co-ordinate the alarm actions based on the pre-configured system set up.

## Visual and audible Indications

### Control, Repeat and Terminal node

An event such as a Fire, Fault or Warning would automatically activate system indications. The control panel, repeat panel and terminal node indicate events by means of:

- messages on a **display/ screen** (Liquid Crystal Display - LCD)
- accompanied with illumination of appropriate colour coded **light**
- and an audible sound from within the panel given by a two tone buzzer.

**Mimic & Zonal panels**

These panels provide indications by means of red **fire** indicators located behind a **site map or zone designation**. An internal buzzer provides an audible indication of a fire and local fault.

The **A4 Mimic panel** also has common lights that operates with *fire, local power supply status and local faults*.

**NOTE:** The A4 mimic panel has an internal buzzer disabling facility which is configured during commissioning of the system. If the buzzer is disabled then it will not sound in an event condition.

# Normal Condition

**Control & Repeat panels plus Terminal node**

A normal operating condition is when there is no fire, fault, warning or test condition present and the mains and standby power supplies to the equipment remains healthy. Under these conditions the display shows a **Panel Healthy** message and the green **Power** light is lit.

Figure 2-2 Normal indications

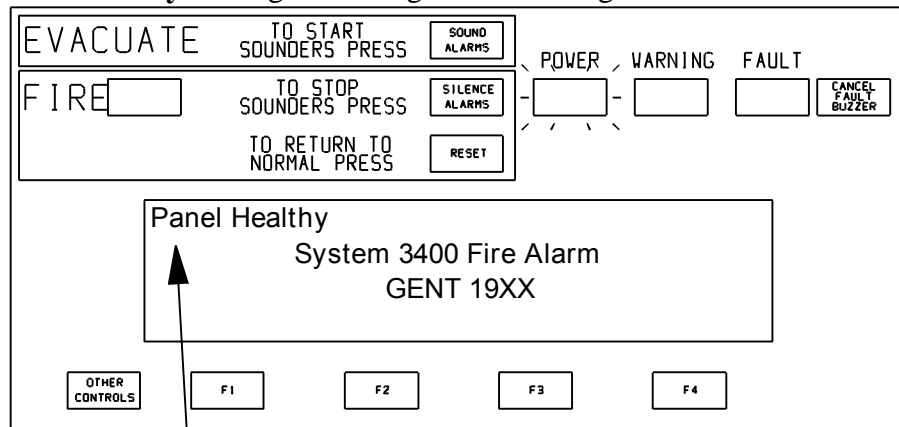

f1145

Repeat panel reads - main panel healthy  
Terminal node reads - Network healthy

**Mimic and Zonal panels**

**NOTE:** There are no indications given at the **standard Mimic and Zonal Panels** of system status.

The **A4 mimic panel** provides a **common fire, local fault and local power supply status** indications. There may also be a display of the system clock.

# Quick Reference

**Log book** All events must be recorded in the **Log Book**.

**System controls** Open the silver door to find:

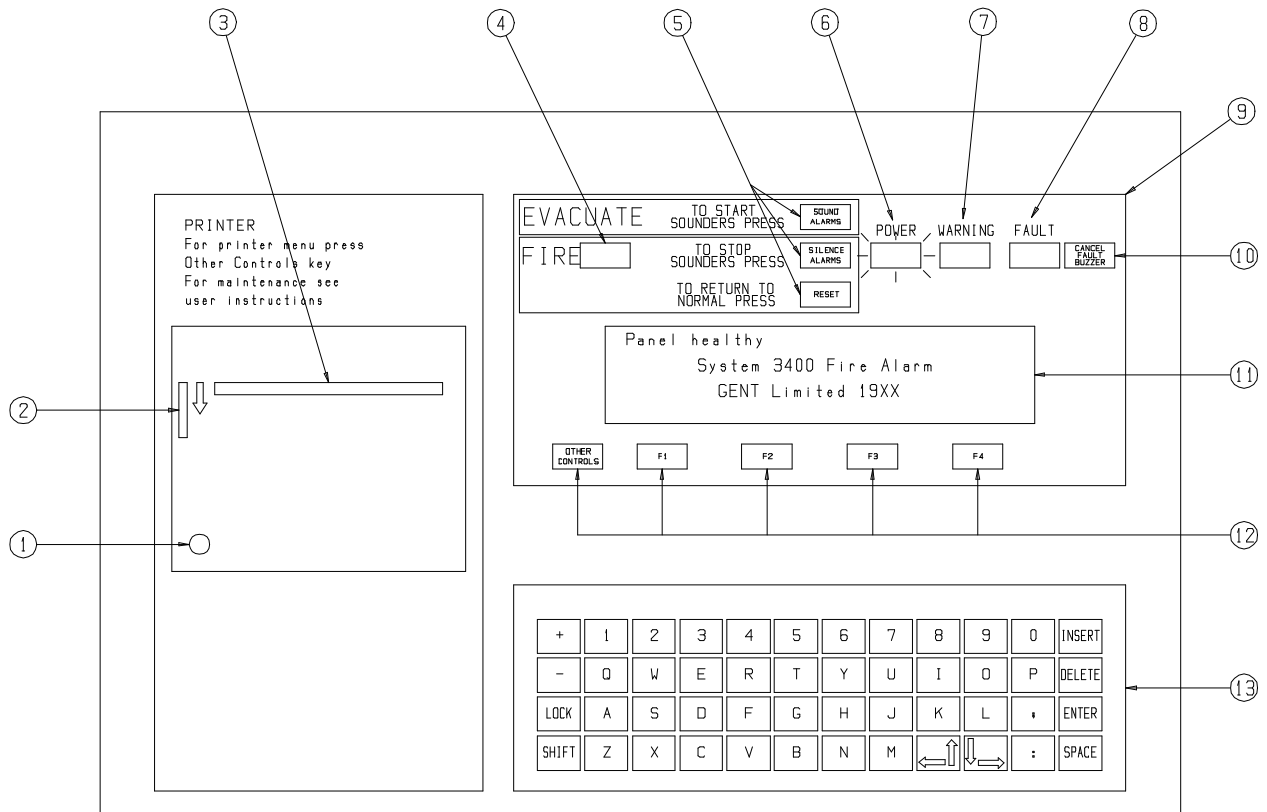

VISUAL INDICATIONS SHOWN ARE WITH NO FIRE FAULT OR WARNING

- ① PRINTER DISABLE SWITCH
- ② PRINTER PAPER FEED KNOB
- ③ PAPER FEED APERTURE
- ④ FIRE LAMP
- ⑤ SYSTEM ALARM CONTROLS
- ⑥ POWER LAMP
- ⑦ WARNING LAMP
- ⑧ FAULT LAMP
- ⑨ SIMPLE KEYBOARD
- ⑩ CANCEL FAULT BUZZER
- ⑪ DISPLAY OF 4 LINES BY 40 CHARACTERS
- ⑫ OTHER CONTROLS & FUNCTIONS F1 TO F4 KEY PADS
- ⑬ FULL KEYBOARD

Figure 3-1 Control panel facade  
m1702

**NOTE:** All customer controls described in this manual are accessible on opening the silver door. The key which opens the door is usually accessible to persons responsible for the fire alarm system.

## How to raise an ALARM of Fire

- Manual call of fire** An alarm of fire can be raised by operating a manual call point.
- Go to the nearest call point that is located away from the fire hazard.
  - Press hard with thumb onto the centre of the glass.
- Automatic fire detection** A fire event is automatically detected and system alarms are automatically actioned by the control panel.

## In the event of a FIRE condition

To silence alarms press the *Silence Alarms* button.

To reset the system press the *Reset* button.

**NOTE:** Excess heat and smoke must be cleared from the fire sensors initiating the Fire conditions. Where a Manual Call Point glass has been broken this must be replaced.

- Mimic and zonal panels** All Fire indications are automatically given by the illumination of lights positioned behind the site plan or zone designation on a Mimic and Zonal panel respectively. There is also a local audible indication. A normally **flashing indication** shows the **first fire**.

These indications are automatically cancelled when the system is RESET.

- A4 Mimic panel** This panel has a further common fire indicator.

## In the event of a FAULT condition

Press the *Cancel Fault Buzzer* button.

All fault repair should be undertaken by engineers responsible for maintaining the Fire Alarm System.

If necessary contact Caradon Gent Service Department for advice.

- Mimic and zonal panels** At the **standard Mimic (but not the A4 mimic) and Zonal Panels** the fault buzzer may be cancelled by operating a keyswitch located on the bottom right hand side.

- A4 Mimic panel** The A4 mimic panel has no local silence fault buzzer facility.



## In the event of a WARNING Condition

A warning condition occurs when there is a disablement within the fire alarm system.

Removal of warning condition should be undertaken by engineers responsible for maintaining the fire alarm system.

## How to sound all FIRE ALARMS

### To Sound Alarms

To sound all alarms in an emergency press the *Sound Alarms* button.

**NOTE:** Normally this function is not configured to be available with the *Terminal node*.

### To Silence Alarms

With the emergency over the alarms can be silenced, press the *Silence Alarms* button.

## How to Test the Display and Indicators

These instructions are applicable for the following equipment:

3404 Control panel	3408 Control panel	3450 Control panel	3505 Terminal node
Yes	Yes	Yes	Yes

Press the *OTHER CONTROLS* button and then select [**Test/Eng**] and [**DispTest**].

### Mimic and Zonal panel

At the Mimic and Zonal panels a lamp test can be performed by operating the keyswitch located on the right hand side of the panel backbox. Note the lights are tested in blocks on a row by row basis.

### A4 Mimic panel

A lamp test is activated at an A4 mimic panel by inserting a 2mm pin like object (for example a small terminal screwdriver) into a hole located on the underside of the panel enclosure.

## How to sound the Master Alarms

These instructions are applicable for the following equipment:

3404 Control panel	3408 Control panel	3450 Repeat panel	3505 Terminal node
Yes	Yes	Yes	No

Press the *OTHER CONTROLS* and select [**Control**].

To start/stop the **Master alarms** press [**Start MA**] or [**Stop MA**] and then select [**Enter**].

## How to sound Sector Alarms

These instructions are applicable for the following equipment:

3404 Control panel	3408 Control panel	3450 Repeat panel	3505 Terminal node
Yes	Yes	Yes	No

**CAUTION:** *The sectors 28-32 are normally reserved for special applications such as for fire extinguishant control.*

Press the *OTHER CONTROLS* and then select [**Control**], [**UserCode**] and enter the 'access code' and then press *Enter* button.

Select <etc>, [**Sector**] and input a Sector number .

Select [**loop**] and enter the number.

Select [**Action**] and then [**Signal 1**] or [**Signal 2**] or [**Signal 3**].

To stop Sector alarms select [**Off**], [**All**] and the appropriate signal to stop [**Signal 1**] or [**Signal 2**] or [**Signal 3**]. Select [**Enter**].

# Emergency Conditions

## How to raise an ALARM of Fire

### Manual call of fire

An alarm of fire can be raised by operating a manual call point.

- a) Go to the nearest manual call point that is located away from the fire hazard.
- b) Press hard with thumb onto the centre of the glass.

**NOTE:** The glass will crack vertically (due to a small score on its reverse side) and collapse into the call point.

**NOTE:** A clear label will hold the broken glass together to prevent injurious splinters.

### Automatic fire detection

A fire event is automatically detected by the Control Panel using data from the sensors and fire inputs from interface units in a standalone system.

An alarm is automatically actioned by the control panel based on preconfigured system setup.

# In the event of a FIRE Condition

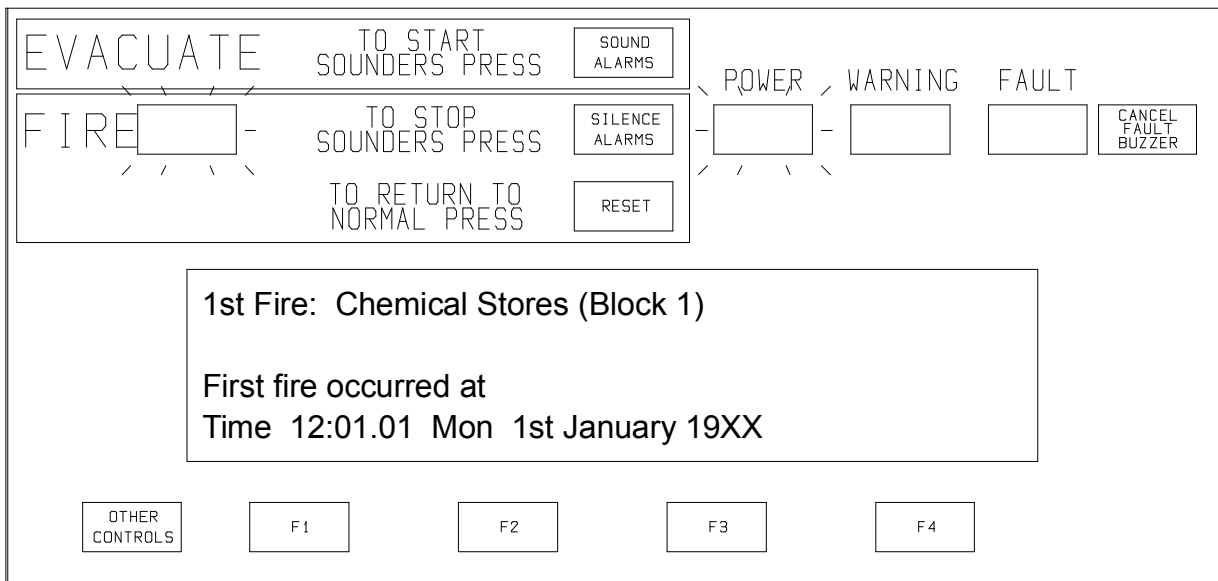

Figure 4-1 Fire indications and controls  
fl148

These instructions are applicable for the following equipment:

3404 Control panel	3408 Control panel	3450 Repeat panel	3505 Terminal node
Yes	Yes	Yes	Yes

## To Silence Alarms

With the emergency over and to silence alarms :

Press the *Silence Alarms* button. Notice the alarms are **silenced** and the **fire buzzer** gives an intermittent sound and the display gives an ‘Alarm Silenced’ message.

## To Reset the System

### Resetting the system

Prior to resetting the fire alarm system, any excess heat and smoke must be cleared from the fire sensors initiating the fire conditions. Where a **manual call point glass** has been broken this must be replaced.

With the alarm activating device cleared for normal operation:

Press the *Reset* button. Notice the display provides the following message ‘Sounders stopped System being Reset - please wait....’. The indications prior to the fire condition are resumed after a short delay.

## Fire Indications

In the event of a fire condition the system alarms are activated automatically. The Panels or Nodes in the system provides the following indications:

- the display shows time, date and location of fire event(s) and panel number is shown at the terminal node.
- Red fire light is lit
- Internal Fire Buzzer is active
- Printer provides a listing of events if it is On.

### Multiple Fires

The '1st fire' message is given at the top of the display. For multiple fires, all 'New Fire' events will appear beneath the '1st Fire'. The display will scroll the information automatically.

Should there be more fires then can appear on the display, the second line on the display will show NewFire information. Every four seconds the **NewFire** text will toggle to show the new fire number, e.g. **Fire n**.

**NOTE:** If a device label is not setup then the display shows the device (outstation) and loop number.

### Mimic & Zonal panels

A **fire** indication is given by illumination of lights behind the *site plan or zone map*, together with the local fire buzzer. A steady or flashing (first fire) indication is given in the event of a fire. The A4 mimic panel has a common fire light which will illuminate with a fire indication.

### Fire detection and indication

All fire events are automatically detected by the control panel using data from the fire sensing devices, such as the fire sensors, manual call points and interface fire inputs in the system.

**NOTE:** To prevent operator confusion all **Fault and Warning events** are not displayed by the control panel during a Fire Condition. These messages and light indications are inhibited until after the incident is over and the system is reset.

### Log Book

All fire events must be recorded in the **Log Book** provided.

### Control Menu

**NOTE:** When the Control Panel is in a fire condition, only some options of the [CONTROL] menu are accessible.

The [**Control**] menu provides the control of Master Alarms, Sector Alarms, Auxiliary Relays etc., see operating other controls part of this manual. The disable and enable options not accessible during a fire condition.

### Fire Events Log

Each fire event is automatically logged in the **Fire Events Log** at the control panel and these events can be recalled using the [**Info**] menu. This menu is only accessible in non-fire condition.

# In the event of a FAULT condition

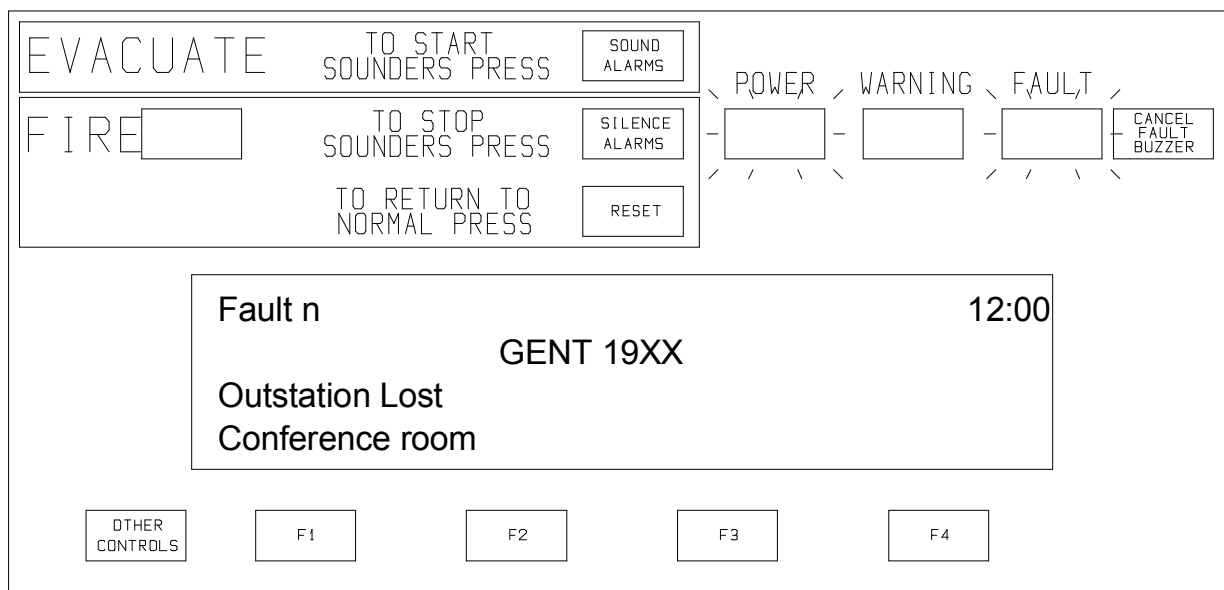

Figure 4-2 Fault indications and controls  
f1149

These instructions are applicable for the following equipment:

3404 Control panel	3408 Control panel	3450 Repeat panel	3505 Terminal node
Yes	Yes	Yes	Partial message

## To Cancel the Fault Buzzer

Press the *Cancel Fault Buzzer* button to stop the fault buzzer from sounding.

## Fault Indications

A fault condition occurs when there is a failure within the system that usually requires rectification action.

In the event of a fault condition:

- the Display shows the location of latest fault event, not indicated on the terminal node.
- Amber Fault light is lit
- Internal Fault Buzzer is active
- Printer provides a listing of events if it is On.
- Total number of active faults in the system appears in the top left of the display.

**NOTE:** The **Fault** light will give a flashing indication when the Control panels mains supply is unhealthy and the the **Power** light is Off.

**NOTE:** If the device label is not setup then the display shows the device outstation and loop number.

**Mimic and Zonal panels**

An internal buzzer will sound when the Mimic or Zonal Panel has a local power supply failure or there is unsuccessful communications with the control panel. The buzzer may be cancelled by operating a keyswitch located on the bottom right hand side. The A4 mimic panel has no local silence fault buzzer facility.

**A4 Mimic panel**

Under rear circumstances the **A4 mimic panel** may display fault codes such as, **COMMS FAULT**, these indications are primarily for use by engineers when commissioning the panel.

**Action to Rectify a Fault Event**

- a) Read the message display for information on the fault event.
- b) Take necessary rectification action. All fault repair should be undertaken by engineers responsible for maintaining the fire system.
- c) If necessary the Caradon Gent Service department should be contacted for advice.
- d) All fault events should be recorded in the **Log Book** provided.

**Fault detection and indication**

All Fault events are automatically detected by the control panel using data from the system. Usually a fault event is generated as a result of abnormal performance for the system.

**NOTE:** To prevent operator confusion all Fault events are detected by the Control panel during a Fire Condition, however their indications are inhibited until after the incident is over and the system is reset.

**Multiple Faults**

The number ‘n’ following the ‘Fault’ on the top left of the display, shows how many active fault events there are present in the fire alarm system.

**Fault Events**

Each Fault event is automatically logged in the **Historic Events Log** at the Control panel and these events can be recalled using the **[Info]** menu. This menu is only accessible in a non-fire condition.

**NOTE:** The information in the active [Fault] events log is automatically cancelled when the condition is removed.

**During a Fire condition**

**NOTE:** The messages and light indication of **faults** are inhibited during a fire condition.

**Fault messages**

The following table shows some fault messages, along with what they mean and possible rectification actions.

**NOTE:** The rectification actions must be attempted by a trained engineer. For advise call the GENT service department.

Message	Meaning	Action
<b>Mains failed</b>	The mains supply to the control panel has failed	Restore the mains supply to the control panel
<b>Battery discharged n</b>	The battery supply to the control panel has been fully discharged	Check the battery and replace if necessary
<b>Master Alarm(s) oc or sc n</b>	There is an open or short circuit fault on the master alarm wiring	Check the wiring and remove the fault. Ensure the end-of-line device is connected in the circuit.
<b>Wiring changed short circuit at card n</b>	There is a short circuit on the loop n wiring	Identify the outstation (device) where a cable fault has occurred and remove the fault.
<b>Interface input os / sc</b>	There is an open or short circuit on the input line of an interface	Locate and remove the wiring fault. Ensure the end-of-line device is connected in the circuit.
<b>Outstation Mains failed</b>	There is a mains supply failure at an interface unit, repeat panel or a mimic panel.	Check the fuse and mains supply to the equipment.
<b>Outstation Battery fault</b>	The battery supply at an interface unit, repeat panel or mimic panel has failed the load test	Check the battery and replace it if necessary



# In the event of a WARNING condition

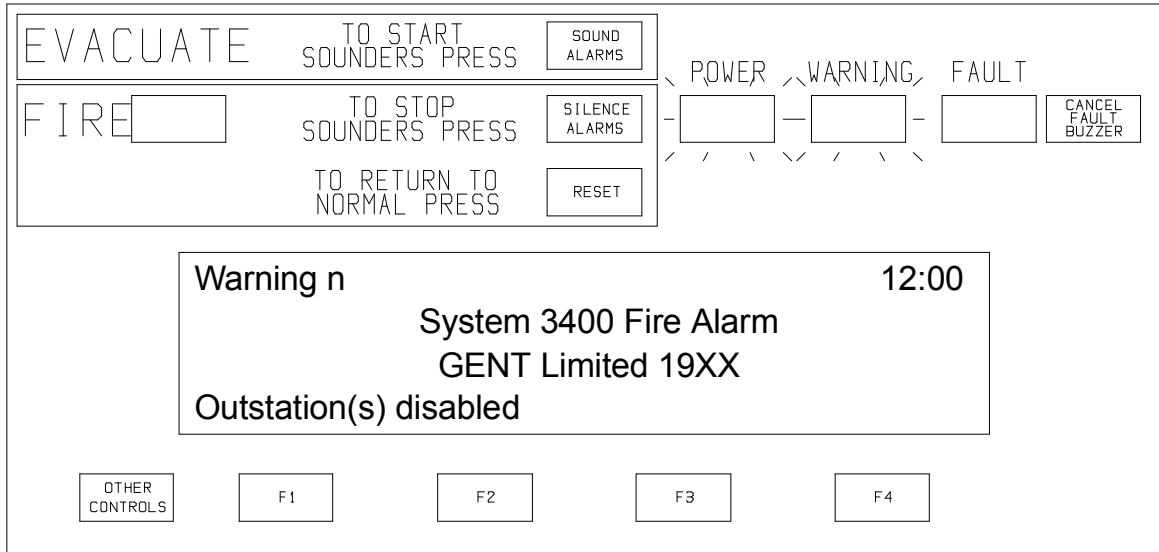

Figure 4-3 Warning Indications  
fl150

These instructions are applicable for the following equipment:

3404 Control panel	3408 Control panel	3450 Repeat panel	3505 Terminal node
Yes	Yes	Yes	Partial message

## Warning Indications

- A warning condition occurs when there is a disablement within the fire alarm system. The panels provides the following indications:
  - the Display shows latest warning event message, not indicated at a terminal node.
  - Amber Warning light is lit
  - Internal **Warning Buzzer** is active (gives an intermittent beep)
  - Total number of active warning in the system appears in the top left of the display.

**NOTE:** The warning light will give a flashing indication when the panels mains supply is unhealthy and the the Power light is Off.

## Action to Remove a Warning Event

- a) Read the message display for information on the warning event.
- b) Take necessary rectification action. All warning rectification should be undertaken by the engineer responsible for maintaining the system.

- c) If necessary the Caradon Gent Service department should be contacted for advice, see ‘Viewing current warning events’.
- d) All warning events should be recorded in the **Log Book** provided.

**Warning detection and indication**

Warning events are automatically detected by the control panel using data from the system. Usually a warning event is generated if there has been a disablement of any part of the system.

**NOTE:** To prevent operator confusion, Warning events are detected by the Control panel during a Fire Condition, however their indications are inhibited until after the incident is over and the system is reset.

**Multiple Warnings**

The number ‘n’ following the ‘Warning’ on top left of the display, shows how many active warning events there are present in the system.

**Warning Events**

Each Warning event is automatically logged in the **Historic Events Log** at the control panel and these events can be recalled using the **[Info]** menu. This menu is only accessible during non-fire conditions.

**NOTE:** The information in the active **Warning** events log is automatically cancelled when the condition is removed.

**During a Fire condition**

**NOTE:** Messages and light indication of **warnings** are inhibited during a fire condition.

**Warning messages**

The following table shows some warning messages, along with what they mean and possible rectification actions.

**NOTE:** The rectification actions must be attempted by a trained engineer. For advise call the GENT service department.

Message	Meaning	Action
Outstation disabled at card n	The device connected to the loop circuit have been manually or automatically disabled	If manually disabled then investigate and, if appropriate, re-enable the outstation
Sector disabled at card n	The fire alarm sector on loop n has been manually or automatically disabled	If manually disabled then investigate and, if appropriate, re-enable the sectors
Disabled Aux Relay n	The auxiliary relay n in the control panel has been manually or automatically disabled	If manually disabled then investigate and, if appropriate, re-enable the aux relay
Master alarms disabled	The master alarms have been manually or automatically disabled	If manually disabled then investigate and, if appropriate, re-enable the master alarms

# To sound all Fire Alarms globally

These instructions are applicable for the following equipment:

3404 Control panel	3408 Control panel	3450 Repeat panel	3505 Terminal node
Yes	Yes	Yes	Normally no Sound alarms

## To Sound Alarms

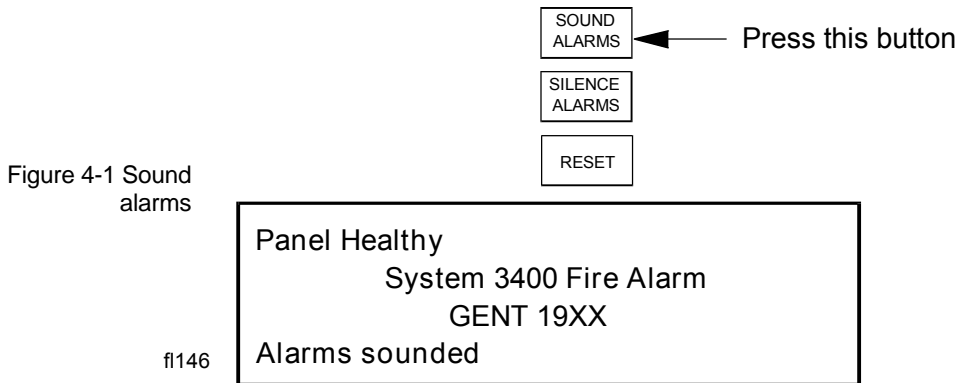

To sound all alarms of the fire system in an emergency:

Press the *Sound Alarms* button. Notice, the alarms of the fire system are sounding and the display gives the an ‘Alarms sounded’ message, plus the internal buzzer sounds.

## To Silence Alarms

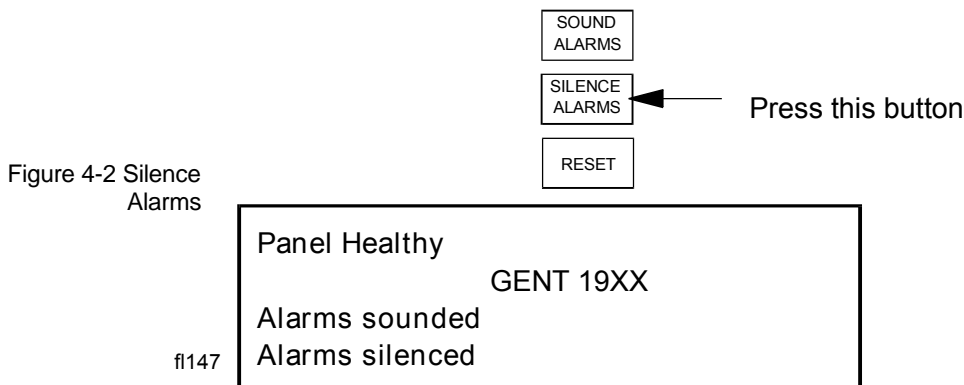

With the emergency over the alarms can be silenced:

Press the *Silence Alarms* button. Notice, the alarms of the fire system are silenced and the display gives the ‘Alarms silenced’ message, plus the internal buzzer is silenced.

**NOTE:** The printer will list this event if it is switched On.

## To sound the Master Alarms

These instructions are applicable for the following equipment:

3404 Control panel	3408 Control panel	3450 Repeat panel	3505 Terminal node
Yes	Yes	Yes	No

The Master alarms are conventional sounders normally installed near the control panel. The fire buzzer in the control panel will operate with the Master alarms, however in some applications the master alarms are not used.

To manually switch On or Off the Master alarms, plus internal (FIRE) buzzer.

- a) Press the *OTHER CONTROLS* button and then the *F1* button to select **[Control]**.
- b) To start or stop the Master Alarm sounders:

To start the Master alarms:

Press the *F1* key to select **[Start MA]**. This prompts a message on the display 'Start Master Alarms'.

To stop the Master alarms:

Press the *F2* key to select **[Stop MA]**. This prompts a message on the display 'Stop Master Alarms'.

- c) Press the *F2* key to select **[Enter]**. Notice the alarm action has been processed and a message appears on the display reading 'Master Sounder on/off'. Note also the internal buzzer sounds.

## To sound the Sector Alarms

These instructions are applicable for the following equipment:

3404 Control panel	3408 Control panel	3450 Repeat panel	3505 Terminal node
Yes	Yes	Yes	No

There can be up to 32 configured sectors per loop circuit. A sector can have fire sensors, manual call points, alarm sounders or interface input/outputs.

**CAUTION:** *The sectors 28-32 are normally reserved for special applications such as for fire extinguishant control.*

To manually switch a Sector to sound Signal 1, Signal 2, Signal 3 or Stop.

- a) Press the *OTHER CONTROLS* button and then the *F1* button to select **[Control]**.

**NOTE:** If **[UserCode]** prompt is not displayed then the following step can be ignored.

- b) Press the *F4* button to select **[UserCode]**. Notice a message on the display 'Enter access code' followed by a flashing cursor. Use the keyboard to input your access code and then press the *Enter* button.
- c) Press the *F4* button to select **<etc>**.
- d) Press the *F1* key to select **[Sector]**. Notice 'Sector' followed by a flashing cursor on the display. Use the keyboard to input a Sector number or range (1-32).
- e) Press the *F2* button to select **[loop]**. Notice 'Loop' followed by a flashing cursor appears on the display. Use the full keyboard to input a Loop number or range (1-8).
- f) Press the *F2* button to select **[Action]**.
- g) To action Sector alarms:

To action Sector alarms signal 1, 2 or 3.

Press the *F2*, *F3* or *F4* button to select **[Signal 1]**, **[Signal 2]** or **[Signal 3]**. Notice 'Signal 1', 'Signal 2' or 'Signal 3' appears on the display.

To stop Sector alarms

Press the *F1* button to select **[Off]**. Notice 'Off From' appears on the display.

Press the *F1* button to select **[All]**, to stop all sector alarm signals or press *F2*, *F3* or *F4* button to stop sector alarms **[Signal 1]**, **[Signal 2]** or **[Signal 3]**.

- h) Press the *F2* button to select **[Enter]**. Notice the selected action has been processed and a 'Sector actioned' message appears on the display.

This page has been intentionally left blank.

# Operating the Other controls

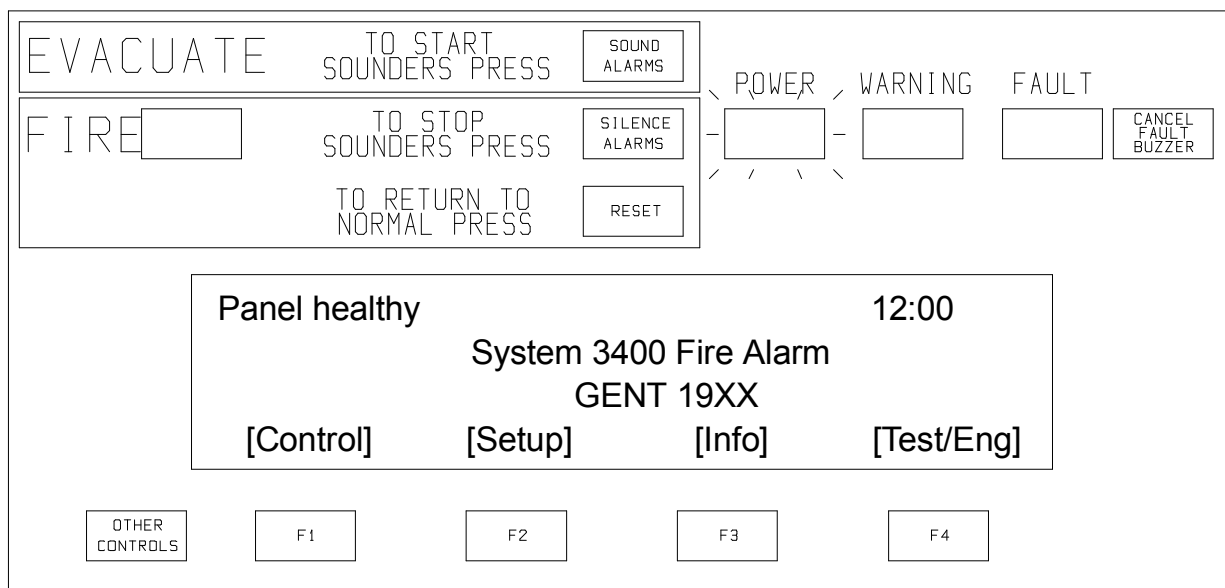

Figure 5-1 Top level menu  
fl152

The *OTHER CONTROLS* button at the panel provides access to all *menu* options that are available under **[Control]**, **[Set Up]**, **[Info]** and **[Test/Eng]** menus.

## Function buttons

The menu prompts appear on the bottom line of the display, above the **function buttons** to prompt the user to make a selection. The top level menu selection can be made by pressing one of the function button *F1* to *F4*, which displays further sub level menu options for selection. When all the entries are made the action is carried out.

## Top level menu

At any level in a menu tree press the *OTHER CONTROLS* button to get out and to display the top level menu.

If the time taken between key presses exceed **5 minutes**, the equipment will automatically remove the display and give a system status indications.

## Params

The **{Params}** prompt is a 'HELP' facility that provides information to the user regarding the input data.

**NOTE:** Most functions under the top level menus are protected with an access code entry. The code is programmed during commissioning of the system and is passed on to the site persons responsible for the fire alarm system.

## Password access

Where an access code is not set up, there is an open entry to operate controls under **[User Code]** and the instructions for entering access code are not applicable.

# Testing the display and indicators

These instructions are applicable for the following equipment:

3404 Control panel	3408 Control panel	3450 Repeat panel	3505 Terminal node
Yes	Yes	Yes	Yes

This facility allows automatic tests to be performed on the Lights, Display and the integral Buzzer.

- a) Press the *OTHER CONTROLS* button and then the *F4* button to select **[Test/Eng]**.
- b) Press the *F1* button to select **[Disp Test]**. Notice the automatic tests are conducted.

### Test Indications

- Lights are lit for approximately 2 seconds.
- Display clears for approximately 2 seconds and then give a system status message.
- Buzzer sounds a dual tone for approximately 2 seconds.

## Testing the Mimic and Zonal panels

### Standard Mimic and Zonal panels

At the standard Mimic and Zonal panels a lamp test can be performed by operating the keyswitch located on the bottom left side of the enclosure. The lights are tested in blocks on a row by row basis, starting from the bottom left of the display aperture.

While the test is operational, blocks of 64 lights switch *On* for **1 second** duration before a next block of lights are tested. The lights may be kept switched *On* for **5 seconds** by stopping the lamp test when it reaches the desired position in the display aperture.

Figure 5-2 Lamp test on standard mimic panel

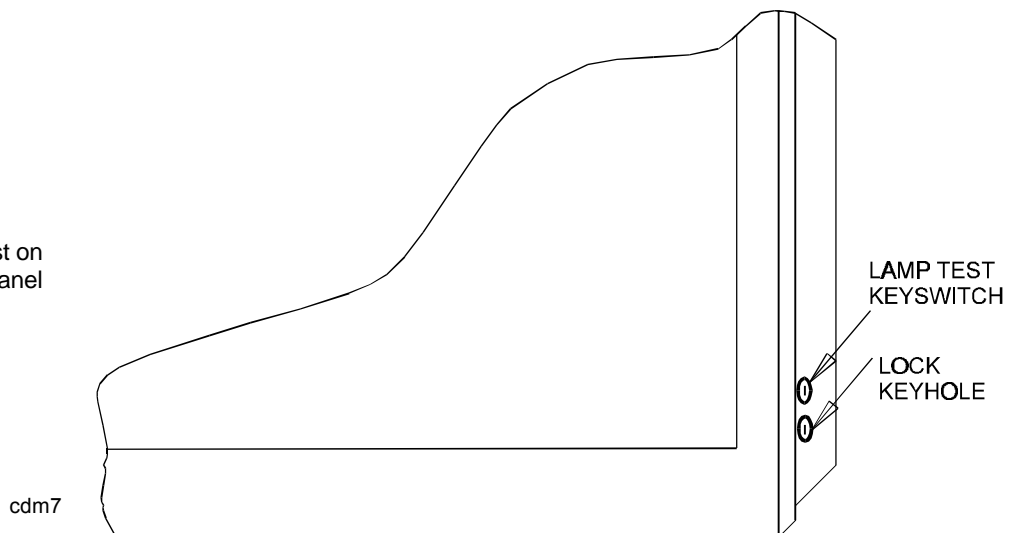



**A4 Mimic panel**

A lamp test is activated at an A4 mimic panel by inserting a 2mm rod like object (for example a small terminal screwdriver) into a hole located on the underside of the panel enclosure.

Figure 5-3 Lamp test at  
A4 Mimic panel

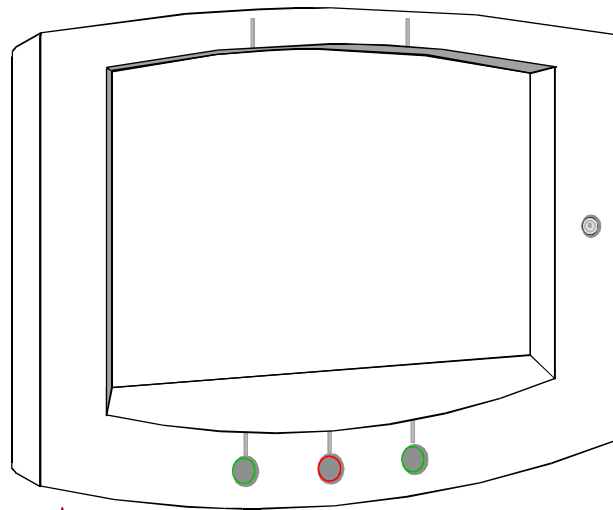

f1380

insert a 2mm diameter pin  
(for example a small  
terminal screwdriver) into  
the hole to operate the lamp  
test switch

The lights are tested in blocks on a row by row basis, starting from the top left of the display aperture.

While the test is operational blocks of 64 lights are automatically switched *On* for **2 seconds** duration before the next block of lights are tested.

## Setting the System Clock

These instructions are applicable for the following equipment:

3404 Control panel	3408 Control panel	3450 Repeat panel	3505 Terminal node
Yes	Yes	Yes	Yes

**CAUTION:** *Incorrectly set system clock would affect the time related fire sensor operation and also give incorrect event time information.*

The system clock is maintained by the 3404 or 3408 control panel. The Time, Date, Month and Year can be set or adjusted .

- Press the *OTHER CONTROLS* button and then the *F2* button to select **[Set up]**.
- Press the *F4* button to select **[UserCode]**. Notice 'User Code' followed by a flashing cursor appears on the display. Use the keyboard to input your access code and then press the *Enter* button.
- Press the *F1* button to select **[Set Clock]**. This provides a display of the system clock. Notice the 'Hour' digits are flashing and requires setting.

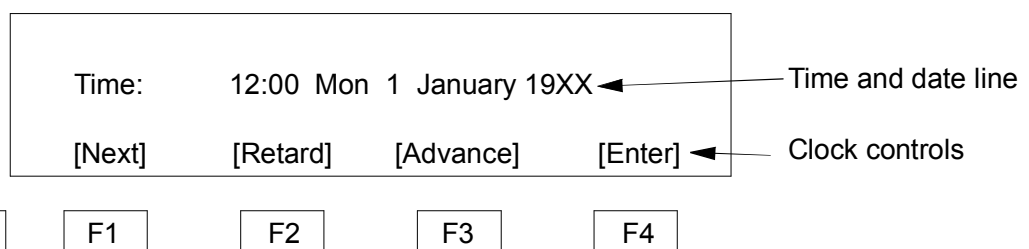

Figure 5-4 Set clock display  
fl153

- Press the *F2* or *F3* button to **[Retard]** or **[Advance]** to a desired setting. A rapid change will occur with a continuous button press and a single step change with each individual button press.
- Press the *F1* button to select **[Next]**. Notice the 'Minute' digits are now flashing.
- Follow the procedure in d) to adjust the Minutes setting.
- Press the *F1* button to select **[Next]**. Notice the 'Date' digits are now flashing.

- h) Follow the procedure in d) to adjust the date setting. Notice days are automatically adjusted.
- i) Press the *F1* button to select [**Next**]. Notice the 'Month' is now flashing.
- j) Follow the procedure in d) to adjust the Month setting.
- k) Press the *F1* button to select [**Next**]. Notice the 'Year' is now flashing.
- l) Follow the procedure in d) to adjust the Year setting.
- m) Press the button *F4* to select [**Enter**]. Notice the display now shows the new time and date.

**NOTE:** All equipment displaying the clock and date information will update themselves with the new entries.

## Viewing the current Fire Log

These instructions are applicable for the following equipment:

3404 Control panel	3408 Control panel	3450 Repeat panel	3505 Terminal node
Yes	Yes	Yes	Yes

The **[Fire]** events log has the capability of storing up to **100** previous fire event information. The logged information can be either called to the display or printed.

**NOTE:** The newest fire is always event number **1** and the oldest fire can be event number **100**.

The logged information consists of time and date of each fire event together with label of the device initiating the fire detection. Further information may appear and can include outstation number (if its label is not set up), loop number, sector number, master sector, zone number and group (if setup), plus panel number for a network system.

- a) Press the *OTHER CONTROLS* button and then the *F3* button to select **[Info]**.
- b) **To display the event(s):**  
Press the *F1* button to select **[Display]**. Notice 'Display' appears on the display.  
  
**To print the event(s):**  
Press the *F2* button to select **[Print]**. Notice 'Print' appears on the display.
- c) Press the *F1* button to select **[Fire]**. Notice 'Fire' followed by a flashing cursor appears on the display.
- d) Use the keyboard to input a fire event number or range (1-100).
- e) Press the *F2* button to select **[Enter]**. Notice the requested logged information is either displayed or printed.

**NOTE:** With the printer switched Off, step b) and PRINT procedures are not applicable.

## Viewing the current Fault Log

These instructions are applicable for the following equipment:

3404 Control panel	3408 Control panel	3450 Repeat panel	3505 Terminal node
Yes	Yes	Yes	Yes

The current **[Fault] events log** is held at each microprocessor controlled card. The logged information can be either printed or displayed.

The logged information consists of time and date of each fault event and the label of the device, if applicable. This data is automatically cancelled from the log when the condition is removed.

a) Press the *OTHER CONTROLS* button and then the *F3* button to select **[Info]**.

b) **To display the event(s):**  
Press the *F1* button to select **[Display]**. Notice 'Display' appears on the display, only if the printer is switched On.

**To print the event(s):**

Press the *F2* button to select **[Print]**. Notice 'Print' appears on the display.

c) Press the *F2* button to select **[Fault]**.

d) **Local System Fault:**

Press the *F2* button to select **[Enter]**. Notice the requested logged information is either displayed or printed.

**Card Fault:**

Press the *F3* button to select **[Card]**. Notice 'On Card' followed by a flashing cursor appears on the display. Use the keyboard to input a card number or range (0-15) and then press *F2* to select **[Enter]**.

**Panel Fault**

Press the *F3* button to select **[Panel]**. Enter the panel number using the keyboard and press the *Enter* button.

e) Press the *F2* or *F3* button to select **[Previous]** or **[Next]** Fault. The events can be scrolled through to the desired fault event.

**NOTE:** With the printer switched Off, step b) and PRINT procedures are not applicable.

## Viewing the current Warning log

These instructions are applicable for the following equipment:

3404 Control panel	3408 Control panel	3450 Repeat panel	3505 Terminal node
Yes	Yes	Yes	Yes

The current **[Warning] events log** is held at each microprocessor controlled card. The logged information can be either printed or displayed.

The logged information consists of time and date of each warning event together with a message. This data is automatically cancelled from the log when a warning condition is removed.

a) Press the *OTHER CONTROLS* button and then the F3 button to select **[Info]**.

b) **To display the event(s):**  
Press the *F1* button to select **[Display]**. Notice 'Display' appears on the display.

**To print the event(s):**

Press the *F2* button to select **[Print]**. Notice 'Print' appears on the display, only if the printer is switched On.

c) Press the *F3* button to select **[Warning]**.  
**If printing the event(s):** Notice 'Print Warning' followed by a flashing cursor appears on the display.

d) **Local System Warning:**  
Press the *F2* button to select **[Enter]**. Notice the most recent logged information is either displayed or printed.

**Card Warning:**

Press the *F3* button to select **[Card]**. Notice 'On Card' followed by a flashing cursor appears on the display. Use the keyboard to input a Card number or range (0-15) and then press the *F2* button to select **[Enter]**. The requested information is either displayed or printed.

**Panel Fault**

Press the F3 button to select [Panel]. Enter the panel number using the keyboard and press the *Enter* button.

e) For displayed events press the *F2* or *F3* button to select **[Previous]** or **[Next]**. The events can be scrolled through to the desired warning information.

**NOTE:** With the printer switched Off, step b) and PRINT procedures are not applicable.

## Viewing the Historic Log

These instructions are applicable for the following equipment:

3404 Control panel	3408 Control panel	3450 Repeat panel	3505 Terminal node
Yes	Yes	Yes	Yes

The **[Historic] events log** has the capability of storing up to 255 previous local event messages. The logged information can be printed or displayed.

**NOTE:** The newest event is always event number 1 and the oldest can be event number 255.

The logged information consists of the time and date of each event together with a message.

- a) Press the *OTHER CONTROLS* button and then the *F3* button to select **[Info]**.
- b) **To display the event(s):**  
Press the *F1* button to select **[Display]**. Notice 'Display' appears on the display.  
  
**To print the event(s):**  
Press the *F2* button to select **[Print]**. Notice 'Print' appears on the display, only if the printer is switched On.
- c) Press the *F4* button to select **<etc>**.
- d) Press the *F1* button to select **[Events]**. Notice 'Events' followed by a flashing cursor appears on the display.
- e) Use the keyboard to input an event number or range (1-255).
- f) Press the *F2* button to select **[Enter]** and notice the requested logged information is either displayed or printed.

**NOTE:** With the printer switched Off, step b) and PRINT procedures are not applicable.

# Viewing Supervisory Active Events

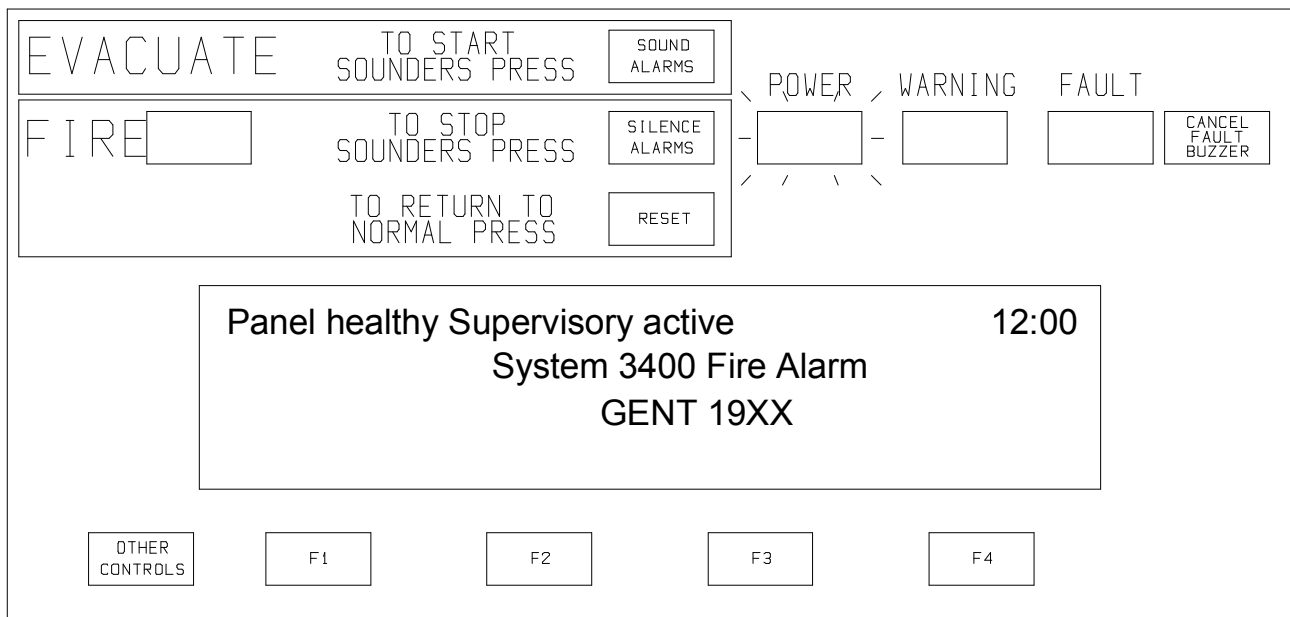

Figure 5-5 Supervisory active f1151

**These instructions are applicable for the following equipment:**

3404 Control panel	3408 Control panel	3450 Repeat panel	3505 Terminal node
Yes	Yes	No	Yes

A **[Supervisory] active event** occurs when a non fire action (via **command build**) has been triggered and is currently in operation.

**NOTE:** Where no label is set up for a command build, the event does will show up as a **supervisory active** event.

To print or display the Supervisory Active information.

- a) Press the *OTHER CONTROLS* key and then the *F3* key to select **[Info]**.
- b) **To display event(s):**  
Press the *F1* key to select **[Display]**. Notice ‘Display’ appears on the display.

**To print event(s):**  
Press the *F2* key to select **[Print]**. Notice ‘Print’ appears on the display.



**For a display:**

Press the *F4* key to select <etc>.

Press the *F3* key to select [**Usercode**].

Press the *F1* key to select [**Supervis**]. Notice 'Display Supervis' appears on the display.

Press the *F1* key to select [**Active**]. Notice 'Display Supervis Active' appears on the display.

**For a printout**

Press the *F4* key to select <etc>.

Press the *F3* key to select [**Usercode**].

Press the *F1* key to select [**Supervis**]. Notice 'Print Supervis' appears on the display.

Press the *F1* key to select [**Active**]. Notice 'Print Supervis Active' appears on the display.

- c) Press the *F2* key to select [**Enter**]. Notice the time and date, Command Build label and the triggering method are displayed.

**NOTE:** *With the printer switched Off, step b) and PRINT procedures are not applicable.*

## Viewing the Supervisory log

These instructions are applicable for the following equipment:

3404 Control panel	3408 Control panel	3450 Repeat panel	3505 Terminal node
Yes	Yes	No	Yes

The [**Supervisory**] log has the capacity of storing up to **255** previously actioned **command build events**. The logged information can be displayed or printed. The newest actioned command is always event **1** and the oldest event is up to **255**.

The information that can be recalled will show the command build block number, its label (if set up), the On time and date of the activation, the trigger device and the Off time and date.

**NOTE:** Command builds triggered by timeblocks will not be written to the log.

To obtain Supervisory information

- a) Press the *OTHER CONTROLS* key and then the *F3* key to select **[Info]**.
- b) **To display the event(s):**  
Press the *F1* key to select **[Display]**. Notice 'Display' appears on the display.

To print the event(s):

Press the *F2* key to select **[Print]**. Notice 'Print' appears on the LCD.

### For a display:

Press the *F4* key to select <etc>.

Press the *F3* key to select **[Usercode]**.

Press the *F1* key to select **[Supervis]**. Notice 'Display Supervis' appears on the display.

Press the *F2* key to select **[Log]**. Notice 'Display Supervis Log' appears on the display followed by a flashing cursor.

### For a printout:

Press the *F4* key to select <etc>.

Press the *F3* key to select **[Usercode]**.

Press the *F1* key to select **[Supervis]**. Notice 'Print Supervis' appears on the display.

Press the *F2* key to select **[Log]**. Notice 'Print Supervis Log' appears on the display followed by a flashing cursor.

- c) Use the full keyboard to input a supervisory event number or range **(1-255)**.

- d) Press the *F2* key to select **[Enter]**. Notice the required information is displayed or printed.

**NOTE:** *With the printer switched off, step b) and PRINT procedures are not applicable..*

## Changing the UserCode Password

These instructions are applicable for the following equipment:

3404 Control panel	3408 Control panel	3450 Repeat panel	3505 Terminal node
Yes	Yes	Yes	Yes

A **password** is required to gain access to options under [**UserCode**] . A new password can be created or a previously created one can be changed.

A password access prevents unauthorised use of options under [**UserCode**], that exist in the [**Control**], [**Set Up**], [**Info**] and [**Test/Eng**] menus.

**NOTE:** The password can be up to 15 characters in length..

- a) Press the *OTHER CONTROLS* button and then the *F4* button to select [**Test/Eng**].
- b) Press the *F4* button to select [**UserCode**].
- c) Use the keyboard to input your existing access code and then press the *Enter* button.
- d) Press the *F4* key to select <etc>, until 'newpass' is displayed.
- e) Press the *F1* button to select [**New Pass**]. Notice a message on the display 'Enter new access code' with a flashing cursor above it.
- f) Use the keyboard to input a new access code and then press the *Enter* button. Notice 'New access code set up' appears on the display.

**NOTE:** Changes to the User Code password at the Control panel is stored on Card O, the card must therefore be backed-up to the Memory Card. If this is not done then the previous password will be restored when a reset is performed.

**NOTE:** It is not possible to backup the passwords at repeat panel and terminal node.

## Using the Printer

**These instructions are applicable for the following equipment:**

<b>3404 Control panel</b>	<b>3408 Control panel</b>	<b>3450 Repeat panel</b>	<b>3505 Terminal node</b>
Yes	Yes	Yes if fitted	Yes

The integral **printer** normally provides a listing of system events. The listing is performed automatically upon occurrence of each event, assuming the printer is switched On.

**NOTE:** *If the printer is switched On permanently, then it will printout occurrence of every event. To prevent waste of paper it may be appropriate to print only when necessary.*

A printout is provided when the **[Print]** option has been selected after entering **[Info]** menu.

If the printer is On then it can be switched Off, or it can produce an automatic paper feed or an automatic printer test. If however the printer is Off then it can only be switched On.

- a) Press the *OTHER CONTROLS* button and then the *F1* button to select **[Control]**.
- b) Press the *F4* button to select **[UserCode]**. Notice a flashing cursor and a message on the display 'Enter access code'.
- c) Use the keyboard to input your access code and press *Enter* button.
- d) Press the *F4* button twice to select **<etc>**.
- e) Press the *F1* button to select **[Printer]**. Notice 'Printer' appears on the display.
- f) **To switch On the Printer:**  
Press the *F3* button to select **[On]** and then the *F2* button to select **[Enter]**. Notice 'Printer is on' appears on the display to show the action has been successfully carried out. Also notice the printer provides a listing of this event.

**To action an Automatic Paper Feed:**

Press the *F2* button to select **[Paper Fd]** and notice the messages and the menu prompts are cleared. The printer then performs eight line feeds.

**To conduct a Printer Test:**

Press the *F1* button to select **[Test]**. Notice the messages and menu

prompts are cleared. A listing is provided by the printer of all the alphanumeric characters it can print..

**To switch Off the Printer:**

Press the *F3* button to select **[Off]** and then the *F2* button to select **[Enter]**. Notice 'Printer is off' appears on the display to confirm the action has been successful. Also notice the printer provides a listing of this event.

# Editing Label Information

These instructions are applicable for the following equipment:

3404 Control panel	3408 Control panel	3450 Repeat panel	3505 Terminal node
Yes	Yes	No	Only panel label

A **label** is used to identify the location a system device such as an Outstation like a fire sensor, alarm sounder, manual call point, repeat panel, and interface unit - including input/output lines. A label of up to 32 alphanumeric characters can be given to a system device, however for a Manual Call Point there can only be up to 28 characters.

A label can be created using **[Enter]** and a previously created label can be modified using **[Modify]**. Use the Information menu to check any previously entered label.

**NOTE:** Changes or entry of label should be backed up to the Memory Card.

## Outstation Label

An outstation is a system device like a fire sensor, manual call point, interface unit, repeat panel or alarm sounder.

- a) Press the *OTHER CONTROLS* button and then the *F2* button to select **[Set Up]**.
- b) Press the *F4* button to select **[UserCode]**. Notice a message on the display 'Enter access code', followed by a flashing cursor.
- c) Use the keyboard to input access code and then press *Enter* button.
- d) Press the *F4* button once to select <etc>.
- e) Use the left and right arrow buttons to move the cursor to the text to be edited.  
**To modify an existing label:** Press the *F1* button to select **[Modify]** and notice 'Modify' appears on the display.  
**To enter a new label:** Press the *F2* button to select **[Enter]** and notice 'Enter' appears on the display.
- f) Press the *F1* button to select **[Label]** and notice 'Label' appears on the display.
- g) Press the *F3* button to select **[Outstatn]**. Notice 'OutStatn' followed by a flashing cursor appears on the display.
- h) Use the keyboard to input an outstation number or range (1-191).

- i) Press the *F2* button to select [**Loop**]. Notice 'Loop' followed by a flashing cursor on the display.
- j) Use the full keyboard to input a loop number or range (1-8).
- k) Press the *F2* button to select [**Enter**].

**If modifying a label:** Notice the previous label appears on the display with a flashing first character to prompt the modification.

**If entering a new label:** Notice the flashing cursor for entry of label information.

- l) Use the keyboard to input a label and then press the *Enter* button. Notice a message on the display 'Card n Set Up'.

### **Input/Output Line label**

Each input/output line of an interface unit can be given a label and a previously entered label can be modified.

- a) Follow the **Outstation label procedure a) to f)** .
- b) Press the *F2* button to select [**IO Line**]. Notice 'IO Line' followed by a flashing cursor on the display.
- c) Using the keyboard enter an input/output number or range (1-4).
- d) Follow the **Outstation label procedure g) to l)**.

### **Group label**

Each **group** can be given a label and an entered label can be modified.

- a) Follow the **Outstation label procedure a) to f)** .
- b) Press the *F4* button once to select <etc>.
- c) Press the *F1* button to select [**Group**]. Notice 'Group' followed by a flashing cursor appears on the display.
- d) Using the keyboard enter a number or range (1-128).
- e) Follow the **Outstation label procedure k) to l)**.

### **Local panel label**

Each control panel and terminal node in a network can be given a label and a previously entered label can be modified.

- a) Follow the **Outstation label procedure a) to f)** .
- b) Press the *F4* button once to select <etc>.
- c) Press the *F2* button to select [**Local**]. Notice 'local' appears on the display.
- d) Follow the **Outstation label procedure k) to l)**.



## Viewing Labels

**These instructions are applicable for the following equipment:**

3404 Control panel	3408 Control panel	3450 Repeat panel	3505 Terminal node
Yes	Yes	No	Only panel label

The identification **label** given to each system device, such as an Outstation like a fire sensor, alarm sounder, manual call point, repeat panel, and interface unit - including input/output lines, plus group and local panel labels can be checked. The information can either be displayed or printed.

**NOTE:** With printer switched Off, step b) and PRINT procedures are not applicable.

### Outstation Label

- a) Press the *OTHER CONTROLS* button and then the *F3* button to select [Info].
- b) A label can be displayed or printed.

#### To display an outstation label:

Press the *F1* button to select [**Display**]. Notice 'Display' appears on the display.

#### To print an outstation label:

Press the *F2* button to select [**Print**]. Notice 'Print' on the display

- c) Press the *F4* button to select <etc> and then the *F2* button to select [**Label**]. Notice 'Label' appears on the display.
- d) Press the *F3* button to select [**OutStatn**]. Notice 'Outstatn' followed by a flashing cursor appears on the display.
- e) Use the full keyboard to input an outstation number or range (1-191).
- f) Press the *F2* button to select [**Loop**]. Notice 'Loop' followed by a flashing cursor appears on the display.
- g) Use the full keyboard to input a loop number or range (1-8).
- h) Press the *F2* button to select [**Enter**]. Notice the selected label information is either displayed or printed.

### Input/Output line Label

An interface unit has four input/output lines. Each line can be given a label that appears on the display during an event.

- a) Follow the procedure for **Outstation label** from a) to c).

- 
- b) Press the *F2* button to select [**IO Line**]. Notice 'IO Line' followed by a flashing cursor on the display.
  - c) Use the keyboard to enter an input/output number or range (1-4).
  - f) Press the *F2* button to select [**Outstatn**]. Notice 'Outstatn' followed by a flashing cursor on the display.
  - g) Follow the procedure for **Outstation label** from e) to h).
- Group label**
- a) Follow the procedure for **Outstation label** from a) to c).
  - b) Press the *F4* button once to select <etc>.
  - c) Press the *F1* key to select [**Group**] and notice 'Group' followed by a flashing cursor appears on the display.
  - d) Use the full keyboard to input a Group number or range (1-128).
  - e) Press the *F2* key to select [**Enter**]. Notice the selected label information is either displayed or printed.
- Local Panel label**
- a) Follow the procedure for **Outstation label** from a) to c).
  - b) Press the *F4* button once to select <etc>.
  - c) Press the *F2* key to select [**Local**], notice 'Local' appears on the display.
  - d) Press the *F2* key to select [**Enter**]. Notice the selected label information is either displayed or printed.

## Saving changes to the Memory Card

These instructions are applicable for the following equipment:

3404 Control panel	3408 Control panel	3450 Repeat panel	3505 Terminal node
Yes	Yes	No	No

Any changes made to Labels or Password should be saved in the Memory Card.

- a) Press the *OTHER CONTROLS* button and then the *F2* button to select **[Set Up]**.
- b) Press the *F4* button to select **[UserCode]**. Notice a flashing cursor and a message on the display 'Enter access code'.
- c) Use the full keyboard to input your access code and then press the *Enter* button.
- d) Press the *F4* button once to select **<etc>**.
- e) Press the *F3* button to select **[Save]**. Notice 'Save All Data To RAM Card' appears on the display.
- f) Press the *F2* button to select **[Enter]**.
- g) Observe confirmation messages as each card is backed up.

**NOTE:** The changes can only be backed up to Memory Card if no warnings are present on the system.

## Enabling or Disabling Parts of the System

These instructions are applicable for the following equipment:

3404 Control panel	3408 Control panel	3450 Repeat panel	3505 Terminal node
Yes	Yes	Yes	Only card communications

To manually **enable or disable** the operation of outstations, interface input lines, sectors, zones, auxiliary relays, master sectors and card communications.

**WARNING:** *Disabling an **extinguishant interface outstation** does not disable the outstation outputs from operating. Hence the **extinguishant agent could be released**. However the disabling of the appropriate sectors (reserved for extinguishant applications) would prevent outputs operating on fire.*

**CAUTION:** *Sectors reserved for extinguishant applications can be manually operated using the control menu.*

**CAUTION:** *It is **only** possible to disable a Manual Call Points (MCP) by disabling the MCP outstation. Disabling MCP is however, not recommended.*

### Enable/Disable Outstations

- a) Press the *OTHER CONTROLS* key and then the *F1* button to select [**Control**].
- b) Press the *F4* button to select [**UserCode**]. Notice a flashing cursor and a message on the display 'Enter access code'.
- c) Use the keyboard to input your access code and then press the *Enter* button.
- d) To disable or enable an outstation.

**To disable:**

Press the *F2* button to select [**Disable**]. This puts a 'Disable' on the display.

**To enable:**

Press the *F1* button to select [**Enable**]. This puts an 'Enable' on the display.

- e) Press the *F1* button to select [**OutStatn**]. Notice 'Outstatn' followed by a flashing cursor appears on the display.
- f) Use the keyboard to input an outstation number or range (1-191).
- g) Press the *F2* button to select [**Loop**]. Notice 'Loop' followed by a flashing cursor on the display.
- h) Use the keyboard to input a loop number or range (1-8).
- i) Press the *F2* button to select [**Enter**]. Notice the action has been processed and confirmed by a message either: 'Outstation(s) enabled' or 'Outstation(s) disabled'.

**NOTE:** Upon disablement of any system equipment the warning light will be lit and the internal buzzer will sound intermittently

### Enable/Disable Input/Output Line(s)

There are four input/output lines on an interface unit and each line can be disabled or enabled.

**CAUTION:** An output line of an interface unit is normally assigned to a sector. The output line can only be disabled by disabling that sector, which has the affect of also disabling all other devices (outstations) in the sector.

- a) Follow the procedure to **enable/disable outstation** from **a) to d)**.
- b) Press the *F2* button to select [**IO Line**]. Notice 'IO Line' followed by a flashing cursor appears on the display.
- c) Use the keyboard to input IO line number or range (1-4).
- d) Press the *F2* button to select [**OutStatn**]. Notice 'OutStatn' followed by a flashing cursor appears on the display.
- e) Use the keyboard to input an outstation number or range (1-191).
- f) Press the *F2* button to select [**Loop**]. Notice 'Loop' followed by a flashing cursor on the display.
- g) Use the keyboard to input a loop number or range (1-8).
- h) Press the *F2* button to select [**Enter**]. Notice the action has been processed and a message appears on the display 'IO line disabled/enabled at Card n'.

**NOTE:** The warning light will be lit upon disablement of any system equipment and the internal buzzer sounds intermittently.

### Enable/Disable Auxiliary Relays

There are two auxiliary relays in the control panel whose operation can be disabled or enabled.

- a) Follow the procedure to **enable/disable outstation** from **a) to d)**.
- b) Press the *F4* button twice to select <etc> and then press the *F2* button to select [**Aux Rly**]. Notice 'Aux Rly' followed by a flashing cursor appears on the display.
- c) Use the keyboard to input an auxiliary relay number or range (1-2).
- d) Press the *F2* button to select [**Enter**]. Notice the action has been processed. Notice the action has been processed and a message appears on the display 'Aux Rly n disabled/enabled'.

**NOTE:** The warning light will be lit upon disablement of any system equipment and the internal buzzer sounds intermittently.

### Enable/Disable Master Alarm

There are two master alarm circuits in the control panel whose operation can be disabled or enabled.

- a) Follow the procedure to **enable/disable outstation** from **a) to d)**.
- d) Press the *F4* button twice to select <etc> and then press the *F1* button to select [**MAalarm**]. Notice 'Master Alarms' appears on the display.
- c) Press the *F2* button to select [**Enter**]. Notice the action has been processed and a message appears on the display 'Master sounder disabled/enabled'.

**NOTE:** The warning light will be lit upon disablement of any system equipment and the internal buzzer sounds intermittently.

### Enable/Disable Sectors

There can be up to 32 sectors configured in a fire alarm system. A sector operation can be disabled or enabled.

- a) Follow the procedure to **enable/disable outstation** from **a) to d)**.
- b) Press the *F3* button to select [**Sector**]. Notice 'Sector' appears on the display followed by a flashing cursor.
- c) Use the keyboard to input a sector number or range (1-32).
- d) Press the *F2* button to select [**Loop**]. Notice 'Loop' followed by a flashing cursor on the display.
- e) Use the keyboard to input a loop number or range (1-8).

- f) Press the *F2* button to select **[Enter]**. Notice the action has been processed and a message appears on the display 'Card n set up'.

**NOTE:** *The warning light will be lit upon disablement of any system equipment and the internal buzzer sounds intermittently.*

### Enable/Disable Zone

There can be up to 128 zones configured in a fire alarm system. The zone operation can be disabled or enabled.

**NOTE:** *Disabling a zone does not disable manual call points in the zone. Therefore a fire alarm of fire can be raised by operating a call point in a disabled zone.*

- a) Follow the procedure to **enable/disable outstation** from **a) to d)**.
- b) Press the *F4* button to select **<etc>** and then press the *F2* button to select **[Zone]**. Notice 'Zone' appears on the display followed by a flashing cursor.
- c) Use the keyboard to input a zone number or range (1-128).
- d) Press the *F2* button to select **[Enter]**. Notice the action has been processed and a message appears on the display 'Zone n enabled or disabled'.

**NOTE:** *The warning light will be lit upon disablement of any system equipment and the internal buzzer sounds intermittently.*

### Other Enable/Disable options

Similarly it is possible to enable or disable **Command Builds, Groups, Master Sector** and **Communications**.

## Switching the Auxiliary Relays

These instructions are applicable for the following equipment:

3404 Control panel	3408 Control panel	3450 Repeat panel	3505 Terminal node
Yes	Yes	Yes	No

These are two **Auxiliary Relays** within the Control Panel, each having twin change over contacts. They are normally configured to operate with sector, fault or warning. However they can be manually switched On or Off.

### To Switch the Auxiliary Relay

- a) Press the *OTHER CONTROLS* button and then the *F1* button to select **[Control]**.
- b) Press the *F4* button to select **[UserCode]**. Notice a flashing cursor and a message on the display 'Enter access code'.
- c) Use the full keyboard to input your access code and then press the *Enter* button.
- d) Press the *F4* button to select the **<etc>**.
- e) Press the *F3* button to select **[Aux Rly]**. Notice 'Aux Rly' followed by a flashing cursor appears on the display.
- f) Use the keyboard to input an auxiliary relay number or range (1-2).
- g) Press the *F2 or F3* button to select **[On] or [Off]**. Notice 'On' or 'Off' appears on the display.
- h) Press the *F2* button to select **[Enter]**. Notice the action has been processed and a message appears on the display 'Auxiliary relay n On/Off'.



## Viewing Cards Information

These instructions are applicable for the following equipment:

3404 Control panel	3408 Control panel	3450 Repeat panel	3505 Terminal node
Yes	Yes	Its respective control panel	local cards only

The status of each **card** in the control panel, such as the Loop Processor Card, Local Controller Card, IO Card or Memory Card can be displayed or printed.

The information can be printed or displayed and includes card type, the card slot position, number of faults and warnings on it and software version number with its date of release. A loop card will have the number of outstation found and how many are Tee Breakers.

### Card Status Information

- a) Press the *OTHER CONTROLS* button and then the *F3* button to select **[Info]**.
- b) **To display the card status:**  
Press the *F1* button to select **[Display]**. Notice 'Display' appears on the display and sub menu appears for selection.  
  
**To print the card status:**  
Press the *F2* button to select **[Print]**. Notice 'Print' appears on the display.
- c) Press the *F4* button once to select **<etc>**
- d) Press the *F3* button to select **[UserCode]**. Notice a flashing cursor and a message on the display 'Enter access code'.
- e) Use the keyboard to input your access code and then press the *Enter* button.
- f) Press the *F2* button to select **[CardStat]**. Notice 'Card Status' followed by a flashing cursor appears on the display.
- g) Use the full keyboard to input a card number or range (0-15).
- h) Press the *F2* button to select **[Enter]**. Notice the requested card status information is either displayed or printed.

**NOTE:** With the printer switched Off, step b) and PRINT procedures are not applicable.

## Viewing a Loop Map

These instructions are applicable for the following equipment:

3404 Control panel	3408 Control panel	3450 Repeat panel	3505 Terminal node
Yes	Yes	No	No

The **map** information of each loop circuit can be displayed or printed. It includes the address of each device on the loop together with address of the connecting previous, next and common line (Tee breaker) devices.

a) Press the *OTHER CONTROLS* button and then the *F3* button to select **[Info]**.

b) **To display the loop map**  
Press the *F1* button to select **[Display]**. Notice 'Display' appears on the display and a new sub menu appears.

**To print the loop map**

Press the *F2* button to select **[Print]**. Notice 'Print' appears on the display.

c) Press the *F4* button once to select **<etc>**.

d) Press the *F3* button to select **[UserCode]**. Notice a message on the display 'Enter access code' followed by a flashing cursor.

e) Use the full keyboard to input your access code and then press *Enter* button.

f) Press the *F4* button to select **<etc>**.

g) Press the *F2* button to select **[Loop Map]**. Notice 'Loop map' followed by a flashing cursor appears on the display.

h) **For a complete loop map:**

Use the keyboard to input a loop number or range (1-2) and then press the *F3* button to select **[Enter]**.

**For a range of outstations on a loop:**

Use the keyboard to input a loop number or range (1-8) and then press the *F2* button to select **[OutStatn]**. Notice 'Outstatn' followed by a flashing cursor appears on the display. Use the keyboard to input outstation number or range (1-191) and then press the *F2* button to select **[Enter]**.

Notice a loop map is either printed or displayed.

## Viewing Network Map

These instructions are applicable for the following equipment:

3404 Control panel	3408 Control panel	3450 Repeat panel	3505 Terminal node
Yes	Yes	No	Yes

The **map** information of panels and nodes can be displayed or printed. It includes the panel number relative to the network controller.

a) Press the *OTHER CONTROLS* button and then the *F3* button to select **[Info]**.

b) **To display the loop map**  
Press the *F1* button to select **[Display]**. Notice 'Display' appears on the display and a new sub menu appears.

**To print the loop map**

Press the *F2* button to select **[Print]**. Notice 'Print' appears on the display.

c) Press the *F4* button once to select **<etc>**.

d) Press the *F3* button to select **[UserCode]**. Notice a message on the display 'Enter access code' followed by a flashing cursor.

e) Use the full keyboard to input your access code and then press *Enter* button.

f) Press the *F4* button to select **<etc>**.

g) Press the *F2* button to select **[Map]** at the control panel or **[Net Map]** at the terminal node.

h) **At a terminal node:**  
Press the *F3* button to select **[Enter]**.

**At a control panel:**

Press the *F2* button to select **[Net Map]** and then press the *F2* button to select **[Enter]**.

Notice a network map with panel numbers are either printed or displayed.

This page has been intentionally left blank.

---

# Site Labels Information

## Site Labels

This section is for insertion of site specific *labels* and *configuration* details. A printout from the computer should be kept here for future reference.

The information in this section should be updated whenever there is a change to the site label or configuration.

This page has been intentionally left blank.

# Log Book Sheets

## Logging Events

A **Log Book** is provided with the 3404 \ 3408 Control panel and 3450 Repeat panel. It is provided to record events such as Fires, Faults and Warnings in the 3400 fire detection and alarm system.

The Log Book is used by **responsible persons** and **GENT Maintenance Engineers** to log any events and information of any work carried out on the system for future reference.

The cover sheet of the log book is filled in after the commissioning of the System and provides useful information such as names and telephone numbers to contact in an emergency.

## Blank Log Sheets

Blank Log Sheet are included in this section which may be copied whenever the current sheet in the Log Book becomes full.

## Completed Log Sheet

A completed log sheet may be hole punched and kept in this section for future reference.

This page has been intentionally left blank.



DATE	TIME	EVENT

ACTION REQUIRED	DATE COMPLETED	NAME

Completed sheets should be stored in the Operating Manual

↑  
FOLD

This page has been intentionally left blank.

DATE	TIME	EVENT

ACTION REQUIRED	DATE COMPLETED	NAME

Completed sheets should be stored in the Operating Manual



This page has been intentionally left blank.

# INDEX

## A

Aux Relays . . . . . 5-26

## B

### Battery

lead acid . . . . . 1-2

lithium . . . . . 1-2

BS5839 . . . . . 1-1

## C

Card . . . . . 5-27

### Control Panel

LCD display . . . . . 2-1

lights . . . . . 2-1

## E

Edit Labels . . . . . 5-17

Equipment . . . . . 2-1

## F

Fault buzzer . . . . . 4-4, 4-7

Fire Buzzer . . . . . 4-2

Function keys . . . . . 5-1

## K

Keyboard . . . . . 2-1

## L

### Lights

Fault . . . . . 4-4

fire . . . . . 4-3

power . . . . . 2-2

Warning . . . . . 4-7

Log Book . . . . . 4-3, 4-5, 4-8

### Logs

fault . . . . . 5-7

fire . . . . . 5-6

historic . . . . . 1-1, 5-9

warning . . . . . 5-8

## M

Manual call point . . . . . 1-2

Master Alarms . . . . . 3-3, 4-10

### Menu Options

[Aux Rly] . . . . . 5-26

[Disable] . . . . . 5-22

[Disp test] . . . . . 3-3, 5-2

[Enable] . . . . . 5-22

[Fault] . . . . . 4-5

[Loop Map] . . . . . 5-28

[Paper Fd] . . . . . 5-15

[Save] . . . . . 5-21

[Set Clock] . . . . . 5-4

[Test] . . . . . 5-15

[UserCode] . . . . . 5-14

{Params} . . . . . 5-1

## P

Panel Healthy . . . . . 2-2

Paper roll . . . . . 1-4

Password . . . . . 5-14

Printer . . . . . 5-15

## S

Sector Alarms . . . . . 3-4, 4-10, 4-11, 4-12

Silence Alarms . . . . . 3-3, 4-9

Sound Alarms . . . . . 3-3, 4-9

## V

View labels . . . . . 5-19

This page has been intentionally left blank.

# System 3400 (with 34000 devices)

## Introduction

This section lists parts used in the Systems 3400 (with 34000 devices) and system 3500. For further details on the availability of the parts, contact GENT.

## Control and indicating equipment

### Control Panels \* - first fix products

13404-02V3	1 - 4 Loop panel set V3
& *13404-80V3	1 - 4 Loop panel back and front cover V3 (1st fix)
13404-12V3+	1 - 4 Loop panel set V3+
& *13404-80V3+	1 - 4 Loop panel back and front cover V3+ (1st fix)
13408-02V3	1 - 8 Loop panel set V3
& *13408-44	1 - 8 Loop panel wall mounted rack (1st fix)
13408-12V3+	1 - 8 Loop panel set V3+
& *13408-44	1 - 8 Loop panel wall mounted rack (1st fix)
13408-02V3	1 - 8 Loop panel set V3
& *13408-44	1 - 8 Loop panel floor standing rack (1st fix)
TBA	1-8 Loop panel Plinth
13408-12V3+	1 - 8 Loop panel set V3+
& *13408-44	1 - 8 Loop panel floor standing rack (1st fix)
TBA	1-8 Loop panel Plinth

**NOTE:** All fire alarm control panels are supplied with **one loop processor card** as standard

13495-24	1 - 4 Loop panel battery pack - 8 off 12V @ 6Ah
13495-48	1 - 8 Loop panel battery pack - 4 off 12V @ 24Ah
09406-06	1 - 4 Loop panel /Mimic weather resistant case
13404-82M2	1 - 4 Loop panel inner box assy, inc printer & keyboard
13408-82	1 - 8 Loop panel inner box assembly
13408-83	1 - 8 Loop panel power supply charger assembly
13408-84	1 - 8 Loop panel battery enclosure

<b>Terminal node</b>	13505-01 & 13505-80	Terminal node (for use in secure network) Backbox (front cover (M2))
<b>Repeat and Mimic Panels</b>	13450-01V3 & *13450-80M2	Repeat panel, no printer Repeat panel backbox and front cover (1st fix)
	13450-02V3 & *13450-80M2	Repeat panel, with printer Repeat panel backbox and front cover (1st fix)
	13450-81V3	Repeat panel inner box assy, no printer & keyboard
	13450-82V3	Repeat panel inner box assy, C/W printer & keyboard
	13460-01V3	Mimic panel C/W drawing

**NOTE:** The Mimic repeat panel plan and programmed EPROM details must be advised at the time of ordering.

13460-02V3	Zonal mimic panel
13495-01	Mimic / repeat battery pack 1 - off 12V @ 6Ah
19222-01	Printer paper
09406-06	1 - 4 Loop panel /Mimic weather resistant case
09410-06	Repeat panel weather resistant case
13496-01M2	Panel key for Mark II
#34604-01	Brown A4 Mimic Panel Set
34614-01	A4 Mimic Display Brown
34624-01	A4 Mimic Control Unit
#34604-02	Grey A4 Mimic Panel Set
34614-02	A4 Mimic Display Grey
34624-01	A4 Mimic Control Unit
#	- Not available at time of issue

## Cards

13430-01V3	Local controller card V3 (LCC)
13430-11V3+	Local controller card V3+ (LCC)
13431-01V3	Loop processor card (LPC)
13433-01V3	1 - 4 Loop panel RAM card
13433-03V3	1 - 8 Loop panel RAM card



13501-01	Secure network card
13432-03V3	I / O card V3
13532-50	Universal I / O card <b>V3</b>
13532-52	Remote printer I/O card
13532-53	Slave I/O card

## Sensors and Accessories

<b>Sensors</b>	34710	Optical heat sensor
	19271-01	Optical chamber
	34770	Optical heat sensor sounder
	19271-01	Optical chamber
	34780	Heat sounder
	19274-01	Heat sounder chamber
	34720	Heat sensor
	19272-01	Heat chamber
	34730	Ionisation sensor
	19273-01	Ionisation chamber
	34729	Environmentally protected Heat sensor
	13474-95	Beam sensor emitter IP55
	13474-96	Beam sensor receiver - <b>long path</b> IP55
	13474-97	Beam sensor receiver - <b>short path</b> IP55
	13474-91	Beam sensor pair set <b>long path</b> IP55 inc bracket and base
	13474-90	Beam sensor pair set <b>short path</b> IP55 inc bracket and base
	#34740	Beam sensor
	#34740-01	Beam sensor emitter
	#34740-02	Beam sensor receiver
	#34741-01	Bracket and Base for 34740 Beam
	#34741-02	Base for 34740 Beam
	07012-31	Conventional Flame detector
	34760	Duct sensor (inc 17908-05 Probes & 34702 Slave LED unit)
	#	- Not available at time of issue
<b>Brackets</b>	13493-05	Beam sensor parallel bracket
	13493-15	Beam sensor angle bracket
<b>Tools</b>	17918-22	Sensor chamber Extractor cup (32000 & 34000)

	17918-23	Optical chamber electronics module removal tool
	17918-24	Ionisation chamber electronics module removal tool
	17918-25	Heat sensor electronics module removal tool
	17918-26	Sensor removal tool kit (32000 & 34000)
<b>Terminal Plate</b>	34700	Terminal plate
	19279-01	Semi-flush sensor mounting kit
	07700-21	Base for Conventional flame detector
<b>T Breaker and Slaves</b>	34701	T breaker Unit
	34702	Slave LED unit
	34703	Slave Relay unit

## Alarm sounders

	34202	2 way electronic sounder
	34203	3 way electronic sounder
	34213	Environmentally protected sounder 3-way electronic sounder
	34777	Repeat sounder

## Manual call points (MCP) 2-way

	34800	Surface mounted MCP
	34807	Surface mounted keyswitch MCP
	34842	Surface mounted MCP with cover
	34812	Surface mounted water resistant MCP
	19289-01	MCP flush fixing plate
	34852	Surface mounted water resistant MCP with cover
	34829	Environmentally protected surface mounted MCP
<b>Spares</b>	13480-09	Spare MCP glasses 10 pack for LPCB approved
	14112-09GR	Spare MCP glasses 10 pack non LPCB approved

## Interfaces

<b>Mains powered</b>	34440	Mains powered fire alarm interface
	34441	Card for mains powered interface
	19104-52	Power relay (for mains powered interface) (up to 4 maximum can be used - supplied with base and diode)
<b>4- Channel Loop powered</b>	34450	Loop powered fire alarm interface
	34451	Card for loop powered interface
	19245-05	Interface line module -up to 4 can be fitted in a loop powered fire alarm interface
	34454	4 way keyswitch <b>door</b> for loop powered interface
<b>1- Channel Loop powered</b>	#34410	Loop powered zone module
	#34415	Single Channel Interface (Loop Powered)
<b>Rack</b>	13445-80	Rack interface back box
	13445-05	Rack interface
	19247-01	Interface rack door
	19247-02	Interface rack keyswitch door
	19247-03	4 way interface line module assembly
<b>Keyswitches</b>	19245-02	2 position keyswitch assembly (for use with optional interface doors)
	19245-03	3-position keyswitch assembly (for use with optional interface doors)
	13445-40	Interface card (loop powered) (up to 10 used in 13445-05 rack interface)
<b>Power supply Unit</b>	19245-06	Power supply unit with 1 relay (for use with loop powered interface unit)
	19245-07	Mains relay (up to 4 for use with 19245-06 unit)

# - Not available at time of issue

<b>Fix Extinguishant</b>	#34460	Loop powered fixed extinguishant interface
	#34461	Card for loop powered extinguishant interface
	# -	Not available at time of issue

## Manuals & Accessories

13499-23	Installation manual <b>V3.3X</b> (for system 3400 with 34000)
13499-26	Operating manual <b>V3.3X</b> (for system 3400 with 34000)
13563-011	GENT Supervisor Operator's Manual

## GENT Supervisor

<b>PC</b>	13563-10	PC for the GENT Supervisor
<b>Graphics only</b>	13564-01	Graphics software
<b>Text only</b>	13565-01	Information mode software
	13565-02	Security mode software
	13565-03	Engineering mode software
	13565-04	Configuration mode software
<b>Text and Graphics</b>	13566-01	Combined text- <b>information mode</b> /graphics software
	13566-02	Combined text- <b>security mode</b> /graphics software
	13566-03	Combined text- <b>engineering mode</b> /graphics software
	13566-04	Combined text- <b>configuration mode</b> /graphics software
	13563-03	A4 text printer with cable and paper
	13563-04	A4 colour graphics printer with cable and paper
	13563-05	Light pen accessory
	4214-006	Fan fold paper (for 13563-03)
	4214-054	A4 paper 5 reams (for 13563-04)

**NOTE:** The Gent Supervisor graphics software requires custom graphics pages

## Converter / Compactor / UPS / Printer

13547-14	Uninterrupted power supply (55 minutes standby)
13547-15	Uninterrupted power supply (14 minutes standby)
13563-02	Converter unit (RS232/RS485)
13548-03	Compactor unit (1 to 8 - RS232)
13562-01	Remote printer
13563-01	Modem (pairs)

This page left intentionally blank.

# GENT and CUSTOMER SERVICES

The location of the nearest Caradon GENT Limited branch offices are included here who can help with any questions.

HEAD OFFICE  
GENT,  
Waterside Road,  
Hamilton Industrial Park,  
Leicester, LE5 1TN.  
TELEX: 342367  
FAX: 0116 2462300  
TEL: 0116 2462000.

EXPORT OFFICE  
Gent,  
Waterside Road,  
Hamilton Industrial Park,  
Leicester,  
LE5 1TN  
U.K.  
TELEX: 342367 GENT G  
FAX: 0116 2462018  
TEL: 0116 2462200

SOUTH EAST SALES & SERVICE CENTRE  
Sidcup House,  
12/18 Station Road,  
Sidcup,  
Kent, DA15 7EX.  
FAX: 0181 302 7739  
TEL: 0181 302 5901

SOUTH WEST SALES & SERVICE CENTRE  
Unit 1,  
Willcock House,  
Southway Drive,  
North Common,  
Warmley,  
Bristol BS15 5LW.  
FAX: 0117 9681272  
TEL: 0117 9618340

SOUTH EAST  
Berkshire Buckinghamshire  
East Sussex Essex  
Hampshire Hertfordshire  
Kent Greater London  
Middlesex Surrey  
West Sussex

SOUTH WEST  
Avon Cornwall  
Devon Dorset  
Dyfed Gloucestershire  
Gwent Powys  
West Glamorgan Somerset  
South Glamorgan Wiltshire  
Mid Glamorgan

MIDLANDS SALES & SERVICE CENTRE  
Waterside Road,  
Hamilton Industrial Park,  
Leicester, LE5 1TN.  
FAX: 0116 2462017  
TEL: 0116 2462400

NORTH SALES & SERVICE CENTRE  
Unit 11,  
The Pavilion,  
Royds Hall Road,  
Leeds, W.Yorks, LS12 6AJ.  
FAX: 0113 2310069  
TEL: 0113 2310040

MIDLANDS NORTH  
Derbyshire Leicestershire  
Lincolnshire Nottinghamshire  
S. Yorkshire Staffordshire  
West Midlands

NORTH  
Cleveland Cumbria  
Durham North Humberside  
N. Yorkshire Northumberland  
Tyne & Wear W. Yorkshire  
Merseyside Cheshire  
Clwyd Gwynedd  
Greater Manchester Lancashire

MIDLANDS SOUTH  
Bedfordshire Cambridgeshire  
Norfolk Northants  
Suffolk Oxfordshire  
Herefordshire Worcestershire  
Shropshire Warwickshire

NORTHERN IRELAND

BELFAST SALES & SERVICE CENTRE  
R. Taylor & Company  
10/12 Edward Street,  
Belfast, BT1 2QA.  
FAX: 01232 327135  
TEL: 01232 231431

SCOTLAND  
SCOTTISH SALES & SERVICE CENTRE  
Carlton Building,  
63 Carlton Place,  
Glasgow, G5 9TW.  
FAX: 0141 420 1731  
TEL: 0141 429 5446

This page has been intentionally left blank.